

TKR series

Extremely quiet and low-vibration
for highly dynamic applications*



* Some features can be different
for certain types for design reasons.

Trademarks are legally protected for the TSUBAKI KABELSCHLEPP GmbH
as a national or international registration in the following countries:
tsubaki-kabelschlepp.com/Trademarks

Subject to change.

TKR series | Overview

TKR series

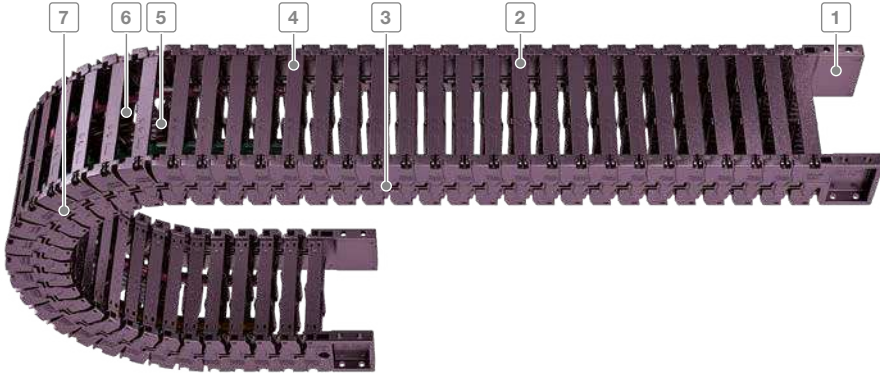

Inner heights



Inner widths



- 1 Variable connection for quick assembly
- 2 Easy and quick to open
- 3 Extremely quiet and low-vibration operation
- 4 Can be opened at any position
- 5 Fixable dividers
- 6 Many separation options for the cables
- 7 Chain link and joint connection with captive connection

tsubaki-kabelschlepp.com/tkr

Features

- Long service life
- Ideal for highly dynamic applications
- High side stability
- Cleanroom compatible
- Modular design allows easy shortening and extending

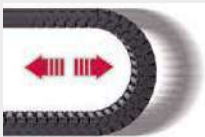
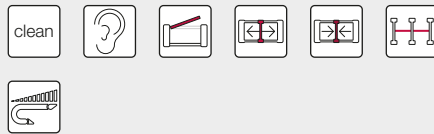

Ideal for highly dynamic applications



UMB end connector to the connection from the face side, from the top or from the bottom



Molded, captive connecting elements

Key for abbreviations
on page 16Design guidelines
from page 62Technical support:
technik@kabelschlepp.de

Type	Opening variant	Stay variant	h_i	h_G	B_i	B_k	B_i - grid	t	KR	Additional load \leq [kg/m]	Cable- d_{max} [mm]
			[mm]	[mm]	[mm]	[mm]	[mm]	[mm]	[mm]		
TKR0150			22	27.5	20–60	34–74	–	15	40–75	2	17.5
TKR0200			28	37	40–120	56–136	–	20	55–150	2.5	22
TKR0260			40	54	50–200	76–226	–	26	75–150	8	32
TKR0280			52	66	50–200	80–230	–	28	75–200	10	41

Cleanroom compatible and long service life

The movable connectors are directly molded on the chain links. In contrast to conventional bore-hole bolt connections, hardly any wear occurs (link abrasion), which makes the TKR type excellent for use in clean rooms.

The special design of the connecting elements additionally increases the service life of the system.

Ideal for highly dynamic applications

The TKR features extremely quiet and low-vibration operation. The so-called polygon effect is reduced to a minimum.

Ideal areas of application are in particular in handling and assembly systems, robots, metrology devices, pick-and-place machines, printing and textile machines. Due to the **very quiet running**, the TKR types are ideal for **low-vibration applications with linear drives**.

TKR series | Overview

Unsupported arrangement			Gliding arrangement			Inner distribution				Installation variants			Page
Travel length ≤ [m]	$v_{max} \leq [m/s]$	$a_{max} \leq [m/s^2]$	Travel length ≤ [m]	$v_{max} \leq [m/s]$	$a_{max} \leq [m/s^2]$	TS0	TS1	TS2	TS3	vertical hanging or standing	lying on the side	rotating arrangement	
1.75	5	200*	–	–	–	●	●	–	–	●	–	–	462
2.75	5	200*	–	–	–	●	●	–	–	●	–	–	468
3.9	5	200*	–	–	–	●	●	–	●	●	–	–	474
4.9	5	200*	–	–	–	●	●	–	●	●	–	–	480

* For values > 20 m/s², please contact us, we are happy to advise you.

Inner heights



Inner widths



Technical manual

Do you require additional information on the TKR type? Our technical manual at tsubaki-kabelschlepp.com/download provides all information for configuring your cable carrier.

TKR0150

Key for abbreviations
on page 16

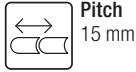

Pitch
15 mm



Inner height
22 mm



Inner widths
20 – 60 mm



Bending radii
40 – 75 mm

Stay variants



Design 030 page 462

Frame with outside detachable crossbar

- Low-vibration plastic frame with particularly long service life thanks to molded chain links.
- **Outside:** Swivable and detachable.

Design guidelines
from page 62

Technical support:
technik@kabelschlepp.de



TOTALTRAX® complete systems

Benefit from the advantages of the TOTALTRAX® complete system. A complete delivery from one source – with a warranty certificate on request! Learn more at tsubaki-kabelschlepp.com/totaltrax

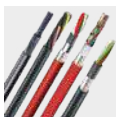

TRAXLINE® cables for cable carriers

Hi-flex electric cables which were especially developed, optimized and tested for use in cable carriers can be found at traxline.de

Unsupported arrangement

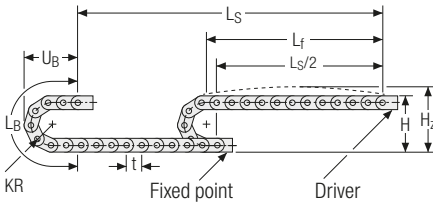

KR [mm]	H [mm]	H _z [mm]	L _B [mm]	U _B [mm]
40	110	140	156	70
50	130	160	187	80
75	180	210	266	105

Inner heights



Inner widths



Load diagram for unsupported length depending on the additional load.

Sagging of the cable carrier is technically permitted for extended travel lengths, depending on the specific application.

Intrinsic cable carrier weight $q_k = 0.3 \text{ kg/m}$ at B_i 20 mm. For other inner widths, the maximum additional load changes.

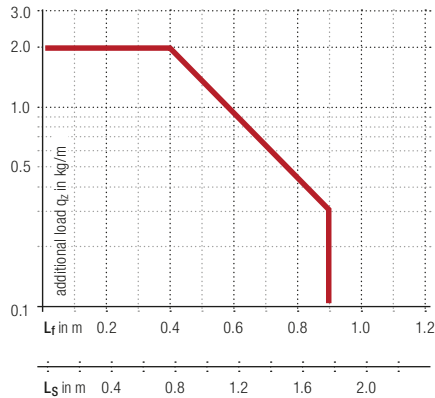

Speed
up to 5 m/s

Acceleration
up to 200 m/s²*

Travel length
up to 1.75 m

Additional load
up to 2.0 kg/m

* For values > 20 m/s², please contact us, we are happy to advise you!

tsubaki-kabelschlepp.com/tkr

More product information online



Assembly instructions etc.:
Additional info via your smartphone or check online at tsubaki-kabelschlepp.com/support



Configure your custom cable carrier here:
online-engineer.de

Stay variant 030 – with outside opening and detachable crossbars

- Low-vibration plastic frame with particularly long service life thanks to molded chain links.
- Swivable and detachable on one side in any position.
- **Outside:** Swivable and detachable.



Key for abbreviations
on page 16



Stay arrangement on each chain link (**VS: fully-stayed**)



B_i 20 – 60 mm

Design guidelines
from page 62

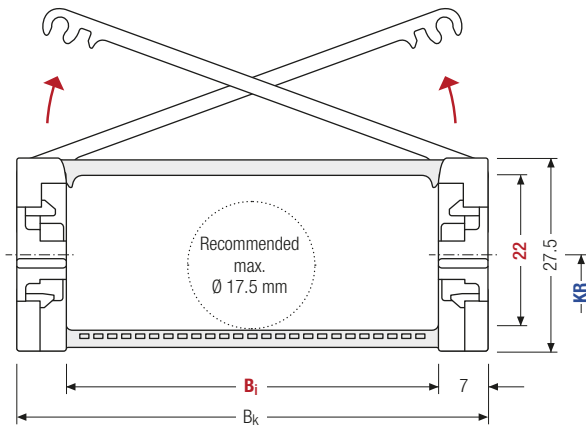

The maximum cable diameter strongly depends on the bending radius and the desired cable type. Please contact us.

Calculating the cable carrier length

Cable carrier length L_k

$$L_k \approx \frac{L_S}{2} + L_B$$

Cable carrier length L_k rounded to pitch t for odd number of chain links

Technical support:
technik@kabelschlepp.de

h_i [mm]	h_G [mm]	B_i [mm]	B_k [mm]	KR [mm]	q_k [kg/m]
22	27.5	20	40	60	$B_i + 14$
				40	50
				75	0.3 – 0.5

Order example



TKR0150

Type

60

B_i [mm]

030

Stay variant

75

KR [mm]

800

L_k [mm]

VS

Stay arrangement

Divider systems

As standard, the divider system is mounted on every 2nd chain link

As a standard, dividers and the complete divider system (dividers with height separation) can be moved in the cross section (**version A**).

The dividers are easily attached to the stay for applications with transverse accelerations and for applications laying on the side by simply turning them.

The arresting cams click into place in the locking grids in the crossbars (**version B**).

Inner heights



Inner widths



Divider system TS0 without height separation

Vers.	a _T min [mm]	a _x min [mm]	a _c min [mm]	a _x grid [mm]	n _T min
A	5	6	4	—	—
B	6	6	4	2	—

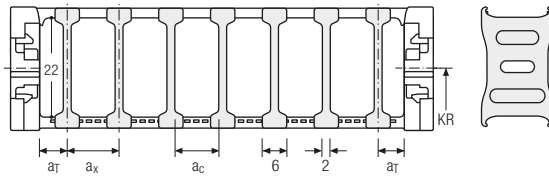

Divider system TS1 with continuous height separation

Vers.	a _T min [mm]	a _x min [mm]	a _c min [mm]	a _x grid [mm]	n _T min
A	5	6	4	—	2
B	6	6	4	2	2

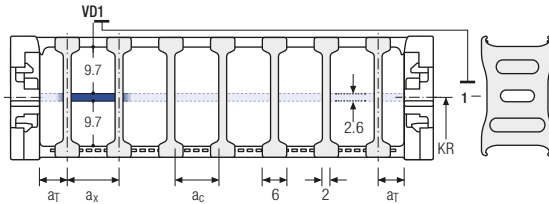

Order example

TS1 ·
 A ·
 3 -
 VD0
 ⋮
 - VD1
 Divider system Version n_T Height separation

Please state the designation of the divider system (**TS0, TS1 ...**), version and number of dividers per cross section [n_T].

If using divider systems with height separation (**TS1**) please also state the positions [e.g. VD1] viewed from the left driver belt. You are welcome to add a sketch to your order.

TKR0150 | End connectors

One-part end connectors – plastic

The plastic end connectors can be **connected from above or from below**. The connection type can be changed by changing the orientation of the end connector.

Key for abbreviations
on page 16

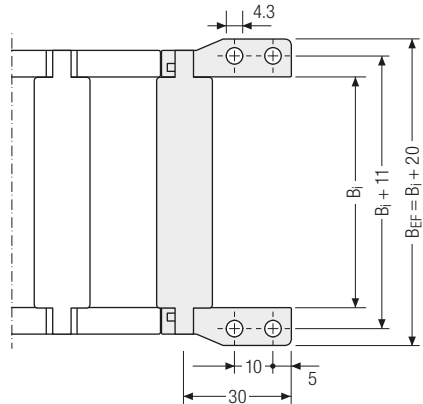
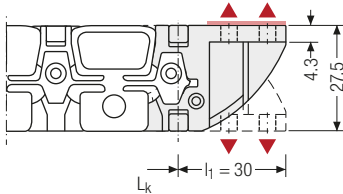

Design guidelines
from page 62

▲ Assembly options



Recommended tightening torque:
0,6 Nm for screws M4

Technical support:
technik@kabelschlepp.de

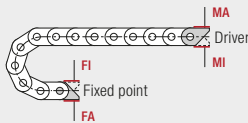

Connection point

F – fixed point
M – driver

Connection type

A – threaded joint outside (standard)
I – threaded joint inside

Order example



Plastic	F	A
Plastic	M	A
End connector	Connection point	Connection type



We recommend the use of strain reliefs before driver and fixed point. See from p. 794.

More product information online



Assembly instructions etc.:
Additional info via your
smartphone or check online at
[tsubaki-kabelschlepp.com/
support](http://tsubaki-kabelschlepp.com/support)



Configure your custom
cable carrier here:
onlineengineer.de



Subject to change.

TKR series

Inner heights



Inner widths



tsubaki-kabelschlepp.com/tkr

TKR0200

Key for abbreviations
on page 16



Pitch
20 mm



Inner height
28 mm



Inner widths
40 – 120 mm



Bending radii
55 – 150 mm

Stay variants

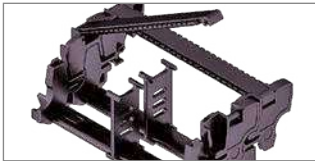

Design 030 page 468

Frame with outside detachable crossbar

- Low-vibration plastic frame with particularly long service life thanks to molded chain links.
- **Outside:** Swivable and detachable
- **Inside:** detachable

Design guidelines
from page 62



Technical support:
technik@kabelschlepp.de

online-engineer.de
Cable Carrier Configurator



TOTALTRAX® complete systems

Benefit from the advantages of the TOTALTRAX® complete system. A complete delivery from one source – with a warranty certificate on request! Learn more at tsubaki-kabelschlepp.com/totaltrax



TRAXLINE® cables for cable carriers

Hi-flex electric cables which were especially developed, optimized and tested for use in cable carriers can be found at traxline.de

Unsupported arrangement

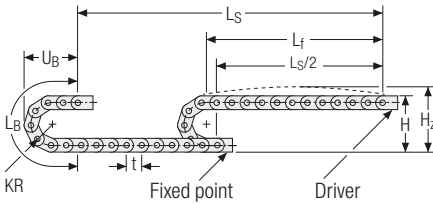

KR [mm]	H [mm]	H _z [mm]	L _B [mm]	U _B [mm]
55	182	252	213	96
75	222	292	276	116
95	262	332	339	136
150	372	442	512	191

Inner heights



Inner widths



Load diagram for unsupported length depending on the additional load.

Sagging of the cable carrier is technically permitted for extended travel lengths, depending on the specific application.

Intrinsic cable carrier weight $q_k = 0.6 \text{ kg/m}$ at B_i 40 mm. For other inner widths, the maximum additional load changes.

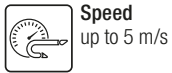
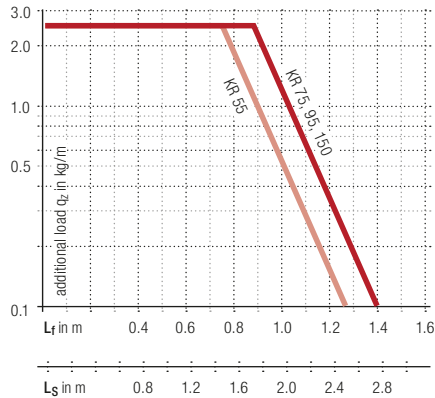

Speed
up to 5 m/s



Acceleration
up to 200 m/s²*



Travel length
up to 2.75 m



Additional load
up to 2.5 kg/m

* For values > 20 m/s², please contact us, we are happy to advise you!

tsubaki-kabelschlepp.com/tkr

More product information online



Assembly instructions etc.:
Additional info via your
smartphone or check online at
[tsubaki-kabelschlepp.com/
support](http://tsubaki-kabelschlepp.com/support)



Configure your custom
cable carrier here:
online-engineer.de

Stay variant 030 – with outside opening and detachable crossbars

- Low-vibration plastic frame with particularly long service life thanks to molded chain links.
- Swivable and detachable on one side in any position.
- **Outside:** Swivable and detachable
- **Inside:** detachable



Key for abbreviations
on page 16



Stay arrangement on each chain link (VS: fully-stayed)



B_i 40 – 120 mm

Design guidelines
from page 62

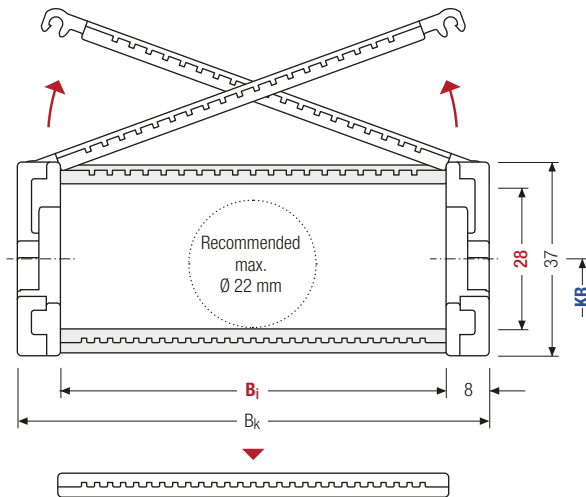

The maximum cable diameter strongly depends on the bending radius and the desired cable type. Please contact us.

Calculating the cable carrier length

Cable carrier length L_k

$$L_k \approx \frac{L_S}{2} + L_B$$

Cable carrier length L_k rounded to pitch t for odd number of chain links

Technical support:
technik@kabelschlepp.de

online-engineer.de
Cable Carrier Configurator

h_i [mm]	h_G [mm]	B_i [mm]						B_k [mm]	KR [mm]				q_k [kg/m]
28	37	40	50	60	80	100	120	$B_i + 16$	55	75	95	150	0.6 – 1.0

Order example



TKR0200

Type

80

B_i [mm]

030

Stay variant

95

KR [mm]

800

L_k [mm]

VS

Stay arrangement

Divider systems

As standard, the divider system is mounted on every 2nd chain link.

As a standard, dividers and the complete divider system (dividers with height separations) can be moved in the cross section (**version A**).

Fixable dividers are available for applications with lateral accelerations and for applications lying on the side.

The arresting cams click into place in the locking grids in the crossbars (**version B**).

Inner heights



Inner widths



Divider system TS0 without height separation

Vers.	a _T min [mm]	a _x min [mm]	a _c min [mm]	a _x grid [mm]	n _T min
A	4	8	6	—	—
B	4	8	6	4	—

B _i [mm]	40	50	60	80	100	120
a _T min [mm]	4	5	6	4	6	6

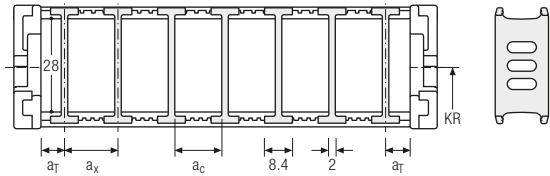

Divider system TS1 with continuous height separation

Vers.	a _T min [mm]	a _x min [mm]	a _c min [mm]	a _x grid [mm]	n _T min
A	4	8	6	—	2
B	4	8	6	4	2

B _i [mm]	40	50	60	80	100	120
a _T min [mm]	4	5	6	4	6	6

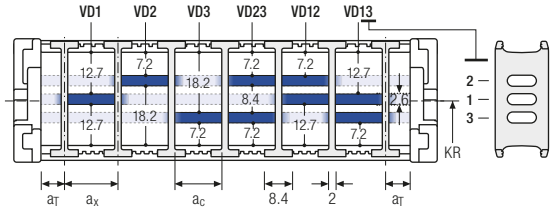

Order example

TS1

A

3

VD0

⋮

VD1

Divider system

Version

n_T

Height separation

Please state the designation of the divider system (**TS0, TS1 ...**), version and number of dividers per cross section [n_T].

If using divider systems with height separation (**TS1**) please also state the positions [e.g. VD1] viewed from the left driver belt. You are welcome to add a sketch to your order.

UMB end connectors UMB – plastic

The universal mounting brackets (UMB) are made from plastic and can be mounted from the top, from the bottom or face on.

Key for abbreviations
on page 16

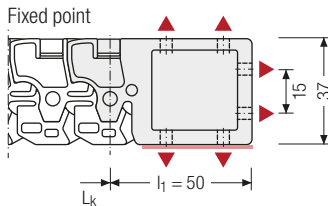
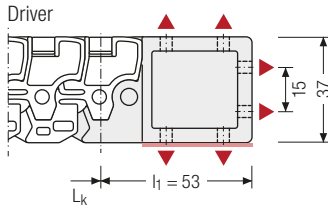

▲ Assembly options

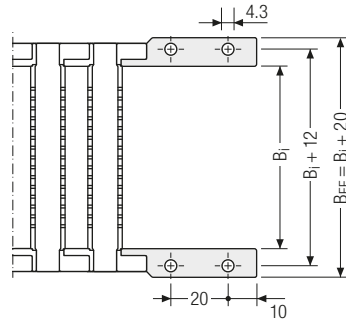

Recommended tightening torque:
0,6 Nm for screws M4

Design guidelines
from page 62

Technical support:
technik@kabelschlepp.de

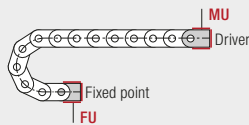

Connection point

F – fixed point
M – driver

Connection type

U – universal mounting bracket

Order example

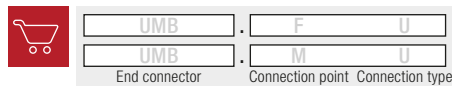

We recommend the use of strain reliefs before driver and fixed point. See from p. 794.

More product information online



Assembly instructions etc.:
Additional info via your
smartphone or check online at tsu-baki-kabelschlepp.com/support



Configure your custom
cable carrier here:
onlineengineer.de



Subject to change

TKR series

Inner heights



Inner widths



tsubaki-kabelschlepp.com/tkr

TKR0260

Key for abbreviations
on page 16



Pitch
26 mm



Inner height
40 mm



Inner widths
50 – 200 mm

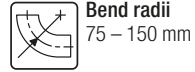

Bend radii
75 – 150 mm

Stay variants

Design guidelines
from page 62

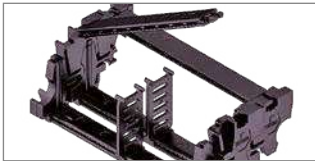

Design 030 page 474

Frame with outside detachable crossbar

- Low-vibration plastic frame with particularly long service life thanks to molded chain links.
- **Outside:** Swivable and detachable
- **Inside:** detachable

Technical support:
technik@kabelschlepp.de



TOTALTRAX® complete systems

Benefit from the advantages of the TOTALTRAX® complete system. A complete delivery from one source – with a warranty certificate on request! Learn more at tsubaki-kabelschlepp.com/totaltrax



TRAXLINE® cables for cable carriers

Hi-flex electric cables which were especially developed, optimized and tested for use in cable carriers can be found at traxline.de

Unsupported arrangement

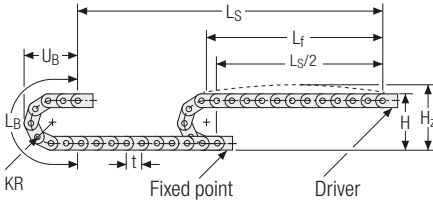

KR [mm]	H [mm]	H _z [mm]	L _B [mm]	U _B [mm]
75	238	308	340	156
100	288	358	418	181
125	338	408	497	206
150	388	458	575	231

Inner heights



Inner widths



Load diagram for unsupported length depending on the additional load.

Sagging of the cable carrier is technically permitted for extended travel lengths, depending on the specific application.

Intrinsic cable carrier weight $q_k = 1.5 \text{ kg/m}$ at B_i 50 mm. For other inner widths, the maximum additional load changes.

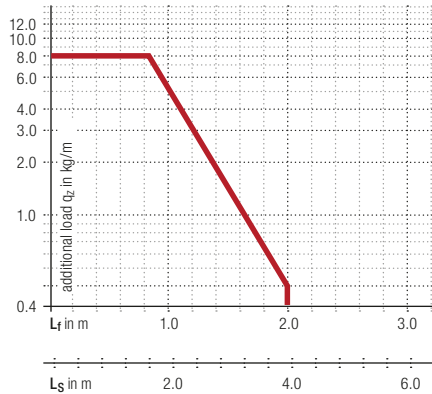

Speed
up to 5 m/s

Acceleration
up to 200 m/s²*

Travel length
up to 3.9 m

Additional load
up to 8.0 kg/m

* For values > 20 m/s², please contact us, we are happy to advise you!

tsubaki-kabelschlepp.com/tkr

More product information online



Assembly instructions etc.:
Additional info via your smartphone or check online at tsubaki-kabelschlepp.com/support



Configure your custom cable carrier here:
online-engineer.de

Stay variant 030 – with outside opening and detachable crossbars

- Low-vibration plastic frame with particularly long service life thanks to molded chain links.
- Swivable and detachable on one side in any position.
- **Outside:** Swivable and detachable
- **Inside:** detachable



Key for abbreviations
on page 16



Stay arrangement on each chain link (**VS: fully-stayed**)



B_i 50 – 200 mm

Design guidelines
from page 62

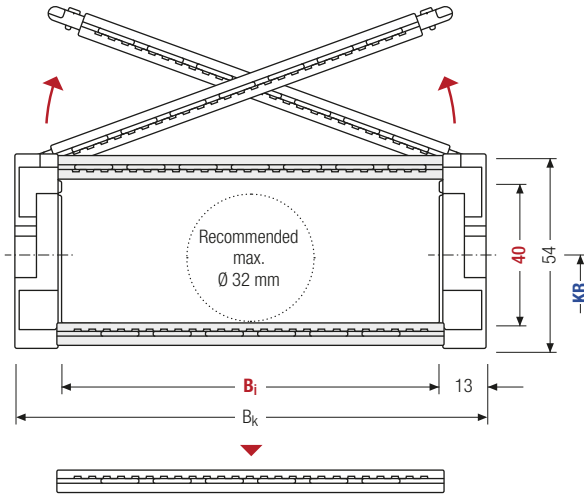

The maximum cable diameter strongly depends on the bending radius and the desired cable type. Please contact us.

Calculating the cable carrier length

Cable carrier length L_k

$$L_k \approx \frac{L_S}{2} + L_B$$

Cable carrier length L_k rounded to pitch t for odd number of chain links

Technical support:
technik@kabelschlepp.de

online-engineer.de
Cable Carrier Configurator

h_i [mm]	h_G [mm]	B_i [mm]				B_k [mm]	KR [mm]				q_k [kg/m]			
40	54	50	75	87	100	125	150	200	$B_i + 26$	75	100	125	150	1.5 – 2.7

Order example



TKR0260

Type

100

B_i [mm]

030

Stay variant

125

KR [mm]

800

L_k [mm]

VS

Stay arrangement

Divider systems

As standard, the divider system is mounted on every 2nd chain link.

Fixable dividers are available for applications with lateral accelerations and for applications lying on the side.

As a standard, dividers and the complete divider system (dividers with height separations) can be moved in the cross section (**version A**).

The arresting cams click into place in the locking grids in the crossbars (**version B**).

Inner heights



Inner widths



Divider system TS0 without height separation

Vers.	a _T min [mm]	a _X min [mm]	a _C min [mm]	a _X grid [mm]	η _T min
A	3	8	5.6	—	—
B	—	8	5.6	4	—

B _i [mm]	50	75	87	100	125	150	200
a _T min [mm]	5	5.5	3.5	6	6.5	7	4

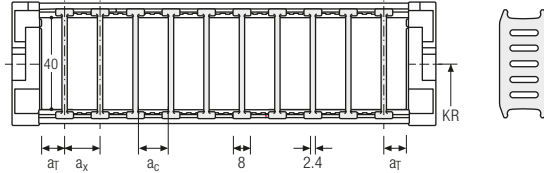

Divider system TS1 with continuous height separation

Vers.	a _T min [mm]	a _X min [mm]	a _C min [mm]	a _X grid [mm]	η _T min
A	3	8	5.6	—	2
B	—	8	5.6	4	2

B _i [mm]	50	75	87	100	125	150	200
a _T min [mm]	5	5.5	3.5	6	6.5	7	4

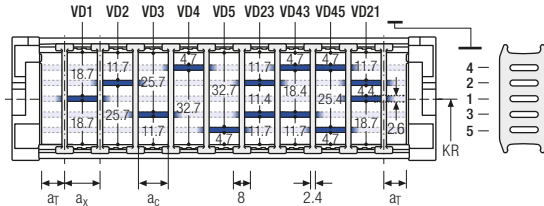

Divider system TS3 with height separation made of aluminum partitions

Vers.	a _T min [mm]	a _X min [mm]	a _C min [mm]	a _X grid [mm]	η _T min
A	3	26	20	—	2
B	—	28	22	4	2

B _i [mm]	50	75	87	100	125	150	200
a _T min [mm]	5	5.5	3.5	6	6.5	7	4

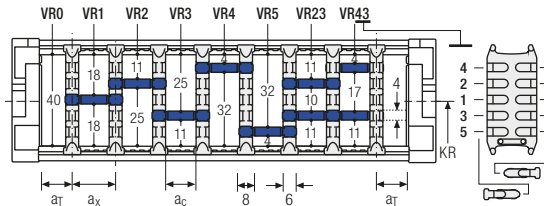

The dividers are fixed by the partitions, the complete divider system is movable in the cross section.

Subject to change.

Aluminum section subdivisions are only available with a_X > 26 mm.

tsubaki-kabelschlepp.com/tkr

UMB end connectors UMB – plastic

The universal mounting brackets (UMB) are made from plastic and can be mounted from the top, from the bottom or face on.

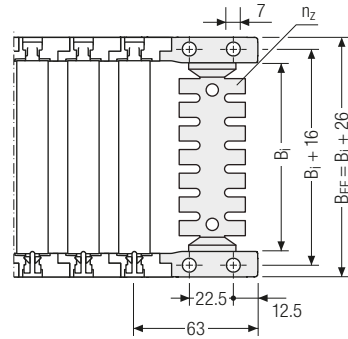
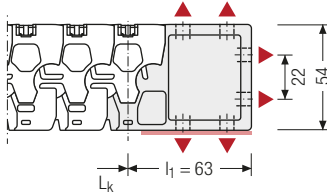

▲ Assembly options

B_i [mm]	B_{EF} [mm]	n_z
50	76	2 x 3
75	101	2 x 5
100	126	2 x 7
125	151	2 x 9
150	176	2 x 11
200	226	–

 Recommended tightening torque:
0,6 Nm for screws M4

Technical support:
technik@kabelschlepp.de

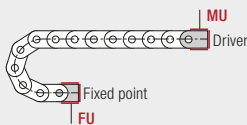

Connection point

F – fixed point
M – driver

Connection type

U – universal mounting bracket

Order example

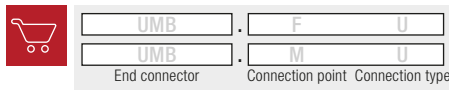

 We recommend the use of strain reliefs before driver and fixed point. See from p. 794.



TKR series

Inner heights



Inner widths



tsubaki-kabelschlepp.com/tkr

Subject to change.

TKR0280

Key for abbreviations
on page 16



Pitch
28 mm



Inner height
52 mm



Inner widths
50 – 200 mm



Bending radii
75 – 200 mm

Stay variants

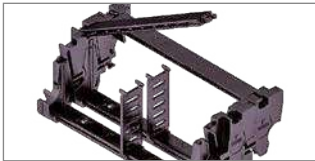

Design 030 page 480

Frame with outside detachable crossbar

- Low-vibration plastic frame with particularly long service life thanks to molded chain links.
- **Outside:** Swivable and detachable
- **Inside:** detachable

Design guidelines
from page 62

Technical support:
technik@kabelschlepp.de



TOTALTRAX® complete systems

Benefit from the advantages of the TOTALTRAX® complete system. A complete delivery from one source – with a warranty certificate on request! Learn more at tsubaki-kabelschlepp.com/totaltrax



TRAXLINE® cables for cable carriers

Hi-flex electric cables which were especially developed, optimized and tested for use in cable carriers can be found at traxline.de

Unsupported arrangement

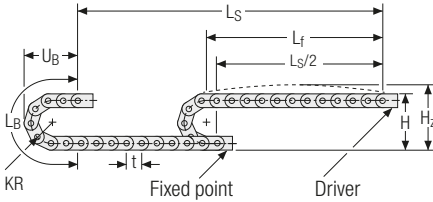

KR [mm]	H [mm]	H_z [mm]	L_B [mm]	U_B [mm]
75	252	322	292	139
100	302	372	370	164
150	402	472	527	214
200	502	572	684	264

Inner heights



Inner widths



Load diagram for unsupported length depending on the additional load.

Sagging of the cable carrier is technically permitted for extended travel lengths, depending on the specific application.

Intrinsic cable carrier weight $q_k = 2.0 \text{ kg/m}$ at B_i 50 mm. For other inner widths, the maximum additional load changes.

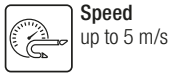
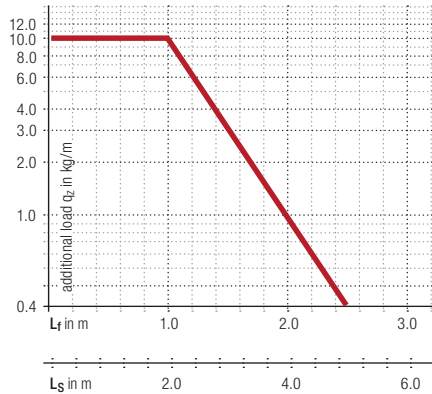

* For values > 20 m/s², please contact us, we are happy to advise you!

tsubaki-kabelschlepp.com/tkr

More product information online



Assembly instructions etc.:
Additional info via your
smartphone or check online at
[tsubaki-kabelschlepp.com/
support](http://tsubaki-kabelschlepp.com/support)



Configure your custom
cable carrier here:
online-engineer.de

Stay variant 030 – with outside opening and detachable crossbars

- Low-vibration plastic frame with particularly long service life thanks to molded chain links.
- Swivable and detachable on one side in any position.
- **Outside:** Swivable and detachable
- **Inside:** detachable

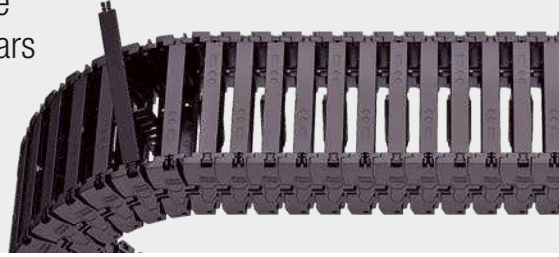

Key for abbreviations
on page 16



Stay arrangement on each chain link (**VS: fully-stayed**)



B_i 50 – 200 mm

Design guidelines
from page 62

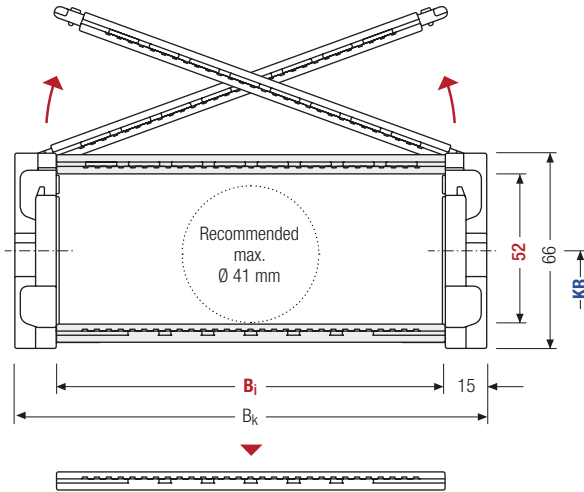

The maximum cable diameter strongly depends on the bending radius and the desired cable type. Please contact us.

Calculating the cable carrier length

Cable carrier length L_k

$$L_k \approx \frac{L_S}{2} + L_B$$

Cable carrier length L_k rounded to pitch t for odd number of chain links

Technical support:
technik@kabelschlepp.de

online-engineer.de
Cable Carrier Configurator

h_i [mm]	h_G [mm]	B_i [mm]				B_k [mm]	KR [mm]				q_k [kg/m]			
52	66	50	75	87	100	125	150	200	$B_i + 30$	75	100	150	200	2.0 – 3.2

Order example



TKR0280

Type

100

B_i [mm]

030

Stay variant

150

KR [mm]

840

L_k [mm]

VS

Stay arrangement

Divider systems

As standard, the divider system is mounted on every 2nd chain link.

Fixable dividers are available for applications with lateral accelerations and for applications lying on the side.

As a standard, dividers and the complete divider system (dividers with height separations) can be moved in the cross section (**version A**).

The arresting cams click into place in the locking grids in the crossbars (**version B**).

Inner heights



Inner widths



Divider system TS0 without height separation

Vers.	a _T min [mm]	a _x min [mm]	a _c min [mm]	a _x grid [mm]	π _T min
A	3	8	5.6	—	—
B	—	8	5.6	4	—

B _i [mm]	50	75	87	100	125	150	200
a _T min [mm]	5	5.5	3.5	6	6.5	7	4

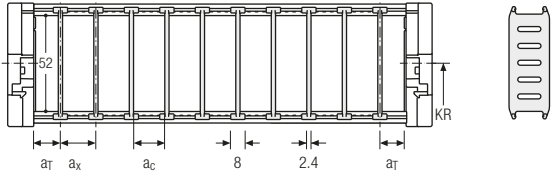

Divider system TS1 with continuous height separation

Vers.	a _T min [mm]	a _x min [mm]	a _c min [mm]	a _x grid [mm]	π _T min
A	3	8	5.6	—	2
B	—	8	5.6	4	2

B _i [mm]	50	75	87	100	125	150	200
a _T min [mm]	5	5.5	3.5	6	6.5	7	4

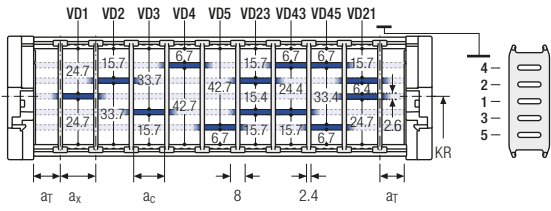

Divider system TS3 with height separation made of aluminum partitions

Vers.	a _T min [mm]	a _x min [mm]	a _c min [mm]	a _x grid [mm]	π _T min
A	3	26	20	—	2
B	—	28	22	4	2

B _i [mm]	50	75	87	100	125	150	200
a _T min [mm]	5	5.5	3.5	6	6.5	7	4

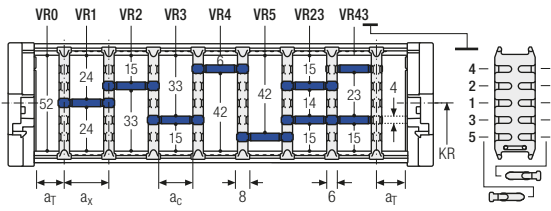

The dividers are fixed by the partitions, the complete divider system is movable in the cross section.

Subject to change.

 Aluminum section subdivisions are only available with a_x > 26 mm.

tsubaki-kabelschlepp.com/tkr

UMB end connectors UMB – plastic

The universal mounting brackets (UMB) are made from plastic and can be mounted from the top, from the bottom or face on.

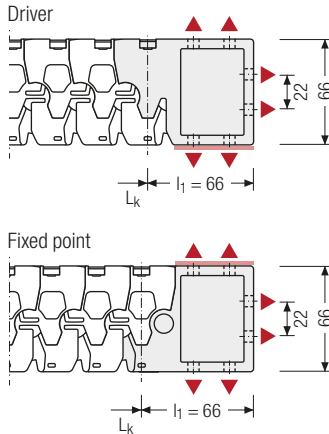
Key for abbreviations
on page 16Design guidelines
from page 62Technical support:
technik@kabelschlepp.deonline-engineer.de
Cable Carrier Configurator

▲ Assembly options

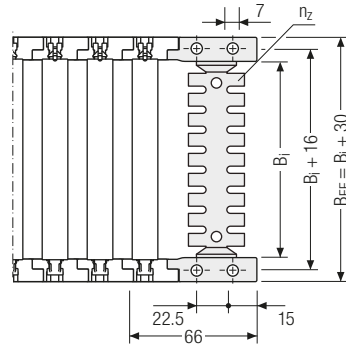

B_1 [mm]	B_{EF} [mm]	n_z
50	80	2 x 3
75	105	2 x 5
100	130	2 x 7
125	155	2 x 9
150	180	2 x 11
200	230	–

Recommended tightening torque:
0,6 Nm for screws M4

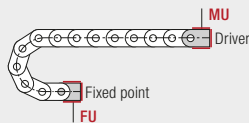

Connection point

F – fixed point
M – driver

Connection type

U – universal mounting
bracket

Order example

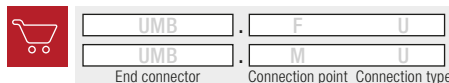

We recommend the use
of strain reliefs before
driver and fixed point. See from
p. 794.

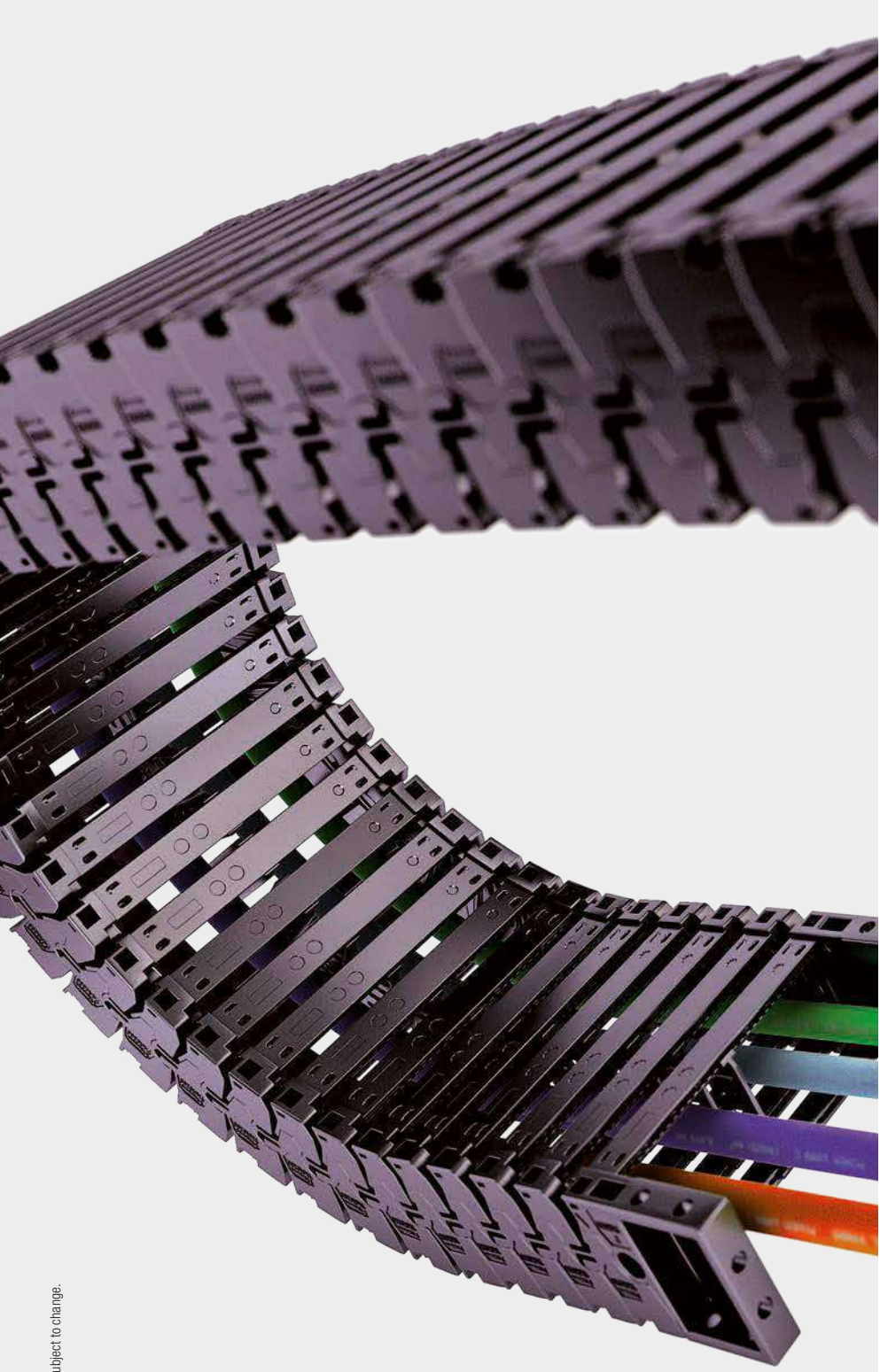

TKR series

Inner heights



Inner widths



tsubaki-kabelschlepp.com/tkr