



triflex[®] R
triflex[®]

twisterchain[®]
twisterband

Robotic-, 3D- and
circular movements

triflex® R | easy triflex® | triflex®

Robotic- and 3D-applications

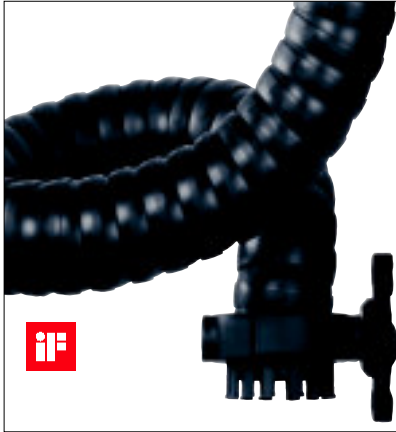

triflex® R - 3D-robotic e-chains®

- The first choice for multiaxis-robots
 - **Variant TRC** - closed design with smooth and robust exterior
 - **Variant TRE** - "easy" design, easy to fill from outside
 - **Variant TRL** - light weight, cost-efficient and very easy to fill, for non robotic applications
 - Torsion ca. $\pm 10^\circ$ per link possible
 - High torsional stability (TRC/TRE)
 - Easy shortening and lengthening
 - Small bending radius, small pitch
- from page 2.4

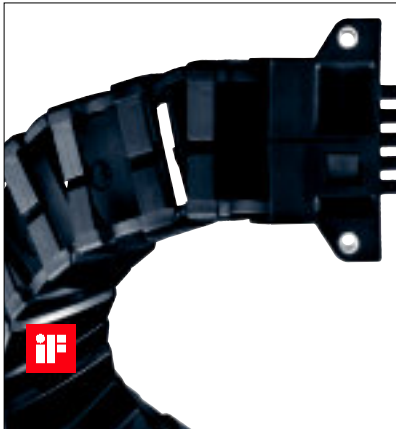

easy triflex® - easy filling

- Easy filling from two sides and complex movements
 - For reparations or supplements of existing triflex®-Systems
 - For simple robotic- and 3D-applications
 - Fast cable assembly with "easy" design
 - Where rectangular shapes fit better
 - Combination of different bending radii and movement directions possible
 - Shortening and lengthening anywhere
 - 3D e-chain® for non robotic applications
- from page 2.30



triflex® - enclosed version

- 3-axis motions in machinery of all kinds (combined circle- and stroke-movements)
 - Completely enclosed - protection against dirt and chips
 - For simple 3D-applications
 - High tensile strength
 - Where rectangular shapes fit better
 - Modular, robust
 - Combinations of varying bending radii and moving axes possible
 - 3D e-chain® for non robotic applications
 - Connecting, separating possible at every link
- from page 2.42

twisterchain® new | twisterchain® classic | twisterband

For circular movements and rotary motions in a small spaces



NEW in this catalog

twisterchain® new - new generation circular e-chains®

We recommend for new constructions!

- Sturdier through intermediate link - heavier loads possible
- Rotary/Spiral movements up to 540°
- Highly dynamic and smoother running (with a new guide trough)
- Modular, variable width, height and radius
- Cable-friendly, smooth interior
- Crossbars snap-open along inner radius
- Rotary speeds up to 2 m/s and more

► from page 2.56



twisterchain® classic - first generation

- For new constructions we recommend: TC32, TC42, TC56 ► from page 2.56
- Fast cable change
- Modular design - variable widths
- Crossbars can be opened on both sides
- For circular motions up to 540° (with special attachments)
- Variable interior separation
- Electrically conductive steel mounting brackets

► from page 2.82



NEW in this catalog

twisterband - rotary motions

- Rotary motions in a small spaces
- 4 sizes available
- Rotary movements up to 7000° (installation position, vertical: up to 3.000°, horizontal 7.000° and more possible)
- Rotary speeds up to 360°/s possible
- Compact, modular and lightweight
- Ribbons can be shortened easily
- Minimum installation space
- Can be used in various installation positions
- Cost-effective

► from page 2.104

3D-robotic e-chains[®]

triflex[®] R



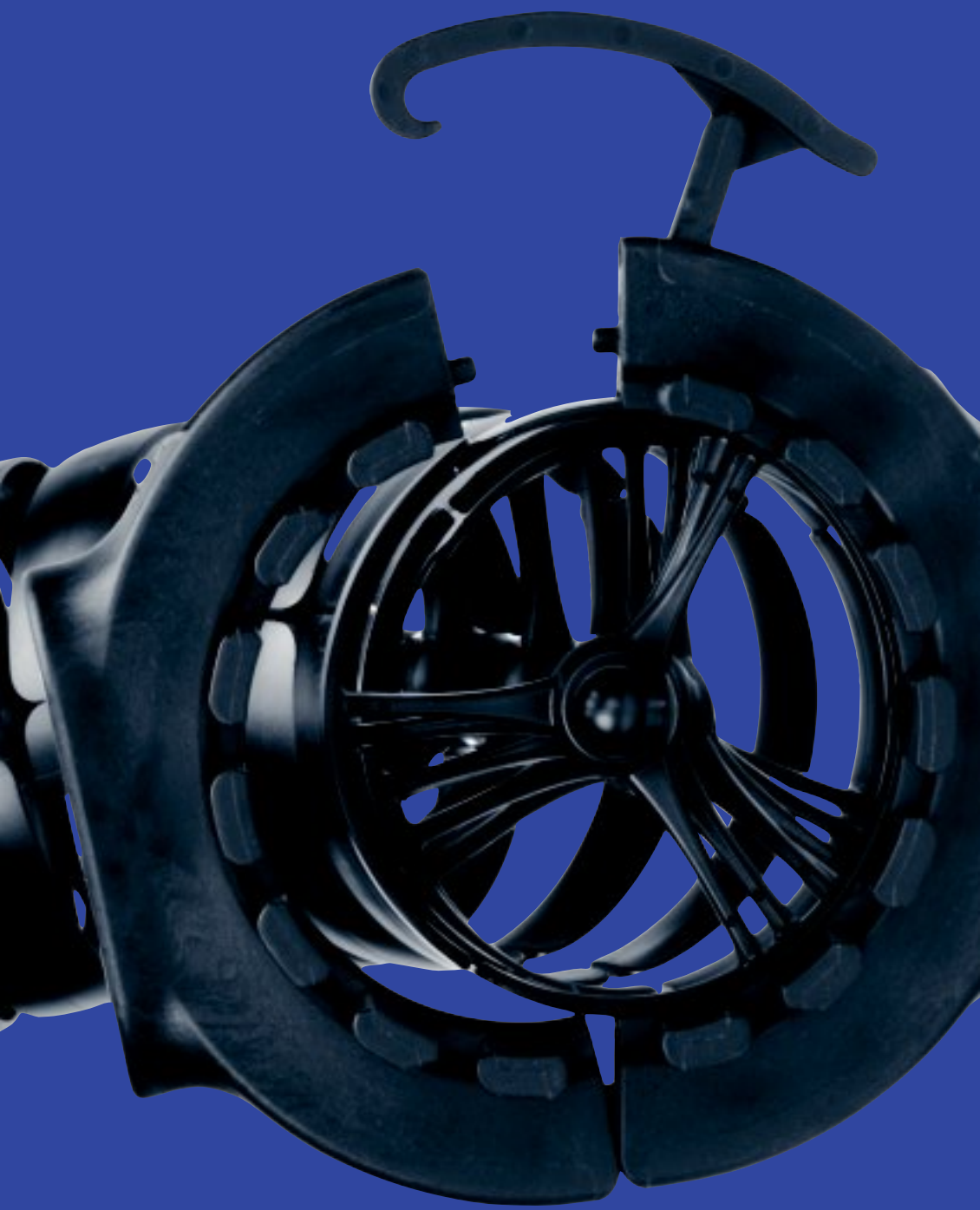

triflex® R - 3-dimensional e-chains® for robots

triflex® R (R for "round") is the third generation of multi-axis e-chains®. Design features include:

- Optional fibre rod for spring loading of the triflex® R
- Approximately $\pm 10^\circ$ twist per e-chain® link
- High tensile strength of the ball-and-socket joint
- Easy assembly and modification due to single moulded link design. No support elements (steel cables, spring suspensions etc.) are necessary

The triflex® R product family now comprises more than 100 components meeting all requirements ranging from those of small palleting robots to large welding robots.

Typical industries and applications

- Robotics/Automation
- Machine tools
- Handling machines - 6-axis
- Packaging machines
- General mechanical engineering, etc.



Video on the web ▶
www.igus.de/triflexR_Film



IF-Design awards for
TRC and TRL-design



Series TRC - Electrically conductive
ESD/ATEX version upon request



Cleanroom suitability
upon request



UL94-V2
classification



triflex® RS - universal module for safe realisation of complex robotic movements
 triflex® RS attaches to the existing fixation point on the robot. Thanks to its low installation height, triflex® R runs parallel and tightly against the robotic arm. Even applications with heavy space restrictions can be realized.



Video on the web ►
www.igus.de/RS_Film



Fiber rod module for directed pretension and universal assembly kit for multifaceted adjustments



triflex® R Set - Routed closely on the robotic arm for extreme flatness

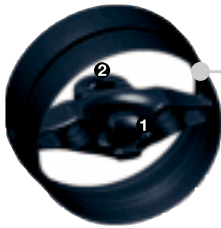

TRC Version - closed design

TRE Version - "Easy"-design - simply press cables in

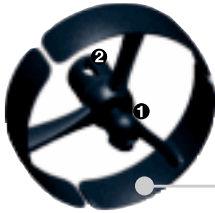
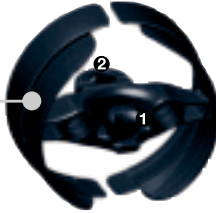

TRL Version - 3-chamber system - the "light" variant of the "Easy" design simply press cables in

Select this system for:

- The first choice for multi-axis-robots
- **Three variants are available:** TRC: Closed design,
 - TRE: "Easy"-design, easy to fill from outside,
 - TRL: The "light" variant of the "Easy"-design
- Universal for general machinery
- Multi-axis (3D) movement
- High torsional stability
- Easy shortening and lengthening
- Smooth interior and exterior edges (TRC)
- Small bend radius
- 1 Ball-and-2 socket principle
- Cables easy to assemble and to replace (TRE/TRL-version)
- triflex® R-Set - compact module for all movements on robots, which can be fixed on existing fastening points
- TRL - one piece, thus very lightweight
- High tensile strengths without additional elements like steel cable and spring elements etc
- You can find more technical data about the material, chemical resistance, temperatures ► **chapter design, from page 1.38**

Selection table

Series	Inner height		max. cable ø		Outer width Ba [mm]	Bending radii R [mm]	Pitch [mm]	Links per m	Page
	Bi 1	Bi 2	d1	d2					
"TRC" - triflex®R closed design, dirt-resistant									
TRC.30	12	10	10	8	34,5	50	11,3	89	2.12
TRC.40	15	13	13	11	43	58	13,9	72	2.12
TRC.60	22,5	19,5	20,5	17,5	65	87	20,4	49	2.12
TRC.70	28	24	26	22	81	110	25,6	39	2.12
TRC.85	33	28	31	26	94,5	135	30,6	33	2.12
TRC.100	37,5	32,5	35,5	30,5	108	145	34,5	29	2.12
TRC.125**	43,3	43,3	41	41	135	182	44,6	23	2.12
"TRE" - triflex®R "Easy"-design for fast installation of conduits									
TRE.30	12	10	10*	8*	34,5	50	11,3	89	2.14
TRE.40	15	13	13*	11*	43	58	13,9	72	2.14
TRE.60	22,5	19,5	20,5*	17,5*	65	87	20,4	49	2.14
TRE.70	28	24	26*	22*	81	110	25,6	39	2.14
TRE.85	33	28	31*	26*	94,5	135	30,6	33	2.14
TRE.100	37,5	32,5	35,5*	30,5*	108	145	34,5	29	2.14
TRE.125**	43,3	43,3	41*	41*	135	182	44,6	23	2.14
"TRL" - a light and economical alternative with an "Easy"-design									
TRL.30	12	10	10*	8*	34,5	50	11,3	89	2.16
TRL.40	15	-	13*	-	45	58	13,9	72	2.16
TRL.60	23	-	20,5*	-	65	87	20,4	49	2.16
TRL.70	28	-	26*	-	81	110	25,6	39	2.16
TRL.100	38	-	35,5*	-	108	145	34,5	29	2.16

* For quick and easy insertion / removal of cables using the easy chain® principle, we recommend a maximum cable diameter of 70% of the specified value.

** TRE.125/TRC.125 - max. cable diameter Ø 41 mm. Max. cable diameter changes to Ø 36 mm only, if shortening/lengthening of a filled triflex® R is required

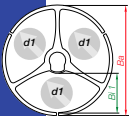
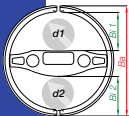
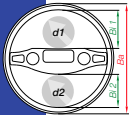

Assembly | TRC.30 · TRC.40 · TRC.60 · TRC.70 · TRC.85 · TRC.100



Hold two pieces together at inner radius and move socket up against the ball's wedged end

Separating | TRC.30 · TRC.40 · TRC.60



Bend triflex® R into its radius and twist apart, counter-clockwise

Separating | TRC.70 · TRC.85 · TRC.100

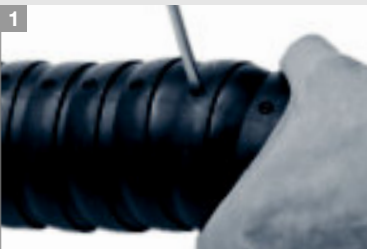

Insert screw driver into the opening of the socket from the top. Then twist apart, counter-clockwise

Assembly | Separating | TRC.125 (C-Version)



Connector principle = Ball head clevis joint (similar to the proven trailer hitch design)
Improved assembly/disassembly for large sizes. Faster assembly with less effort



Assembly | TRE.30 · TRE.40 · TRE.60 · TRE.70 · TRE.85 · TRE.100

Hold two pieces together at inner radius and move socket up against the ball's wedged end.
Push until a clicking sound indicates a secure fit of ball into socket (e-chain* section exposed for the purpose of demonstration)

Separating | TRE.30 · TRE.40 · TRE.60

Bend triflex® R into its radius and twist apart, counter-clockwise

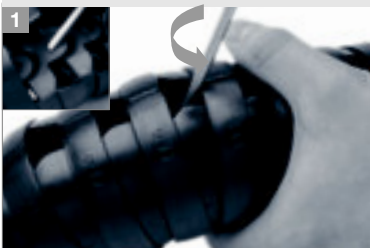
Separating | TRE.70 · TRE.85 · TRE.100

Insert screw driver into the opening of the socket from the top.
Then twist apart, counter-clockwise

Filling | TRE.30 · TRE.40 · TRE.60 · TRE.70 · TRE.85 · TRE.100

Easy to fill - simply press cables in...

...and easy to take the cables out

Assembly | TRL.30 · TRL.40 · TRL.60 · TRL.70 · TRL.100



igus® triflex® R TRL - very easy to assemble - simply press the ball into the socket, ready!

Separating | TRL.30 · TRL.40 · TRL.60 · TRL.70 · TRL.100



Just twist the ball slightly to remove it from its socket

Filling | TRL.40 · TRL.30 · TRL.60 · TRL.70 · TRL.100



Easy to fill - simply press cables in...

...and easy to take the cables out

Installation | Mounting bracket in this case, a "light" bracket with an intermediate connection



Easy assembly - to open, push a screwdriver against one side and prise apart



TRC - closed,
chip-resistant design

High tensile strength thanks to
special ball-and-socket principle

Able to move multi-dimensionally -
Twist up to approx. $\pm 10^\circ$ per link
possible in longitudinal axis

Impact-resistant, dirt-repelling,
rugged and abrasion-resistant

Smooth, rounded exterior

Easy assembly and dismantling -
one die-cast component

High stability - thanks
to exterior stop dogs

Small bending radii and short pitch

igumid NB: -40° up to $+80^\circ$ C
VDE 0304 IIC UL94 V2

Easy attachment and intelligent
accessories onto the robot/machine

⊕ Robotic applications, closed, chip-resistant

When to use Series TRC:

- If a secure, closed and chip-resistant energy supply is required for multi-dimensional (3D) movements
- If high torsional stability is required
- If the system has to be shortened or lengthened easily
- If small bending radii are required
- If high tensile strength is important
- If a smooth and robust exterior against interfering edges is required

⊖ When to use a different igus® Series:

- For circular movements with high loads
- ▶ **System twisterchain® new, from page 2.56**
- When a rugged, easy to fill variant is needed
- ▶ **triflex® R - TRE, page 2.14**
- If a more simple and low-cost 3D-solution is required
- ▶ **triflex® R - TRL, page 2.16**



triflex® R-Set - compact module for
all movements on robots available



Available from stock. Delivery in 24h or today!*

*Delivery time means time until shipping of goods



3D-CAD files, configurators, PDF ▶ www.triflex-r.eu

triflex® R | Series TRC | Closed design, dirt-resistant

Series TRC Standard	Series TRC C-Version	Bi 1 [mm]	Bi 2 [mm]	Ba [mm]	R [mm]	d1 [mm]	d2 [mm]	Pitch [mm]	Links/m	Weight [kg/m]
TRC.30.050.0	-	12	10	34,5	050	10	8	11,3	89	≈ 0,27
TRC.40.058.0	-	15	13	43	058	13	11	13,9	72	≈ 0,37
TRC.60.087.0	-	22,5	19,5	65	087	20,5	17,5	20,4	49	≈ 0,85
TRC.70.110.0	-	28	24	81	110	26	22	25,6	39	≈ 1,32
TRC.85.135.0	-	33	28	94,5	135	31	26	30,6	33	≈ 1,75
TRC.100.145.0	TRC.100.145.0.C*	37,5	32,5	108	145	35,5	30,5	34,5	29	≈ 2,38
TRC.125.182.0	X ¹⁾	43,3	43,3	135	182	41	41 ²⁾	44,6	23	≈ 4,70

¹⁾ TRC.125: C-version is standard! ²⁾ Available upon request. Delivery time approx. 6-8 weeks after order

²⁾ Max. cable diameter Ø 41 mm. Max. cable diameter changes to Ø 36 mm only, if shortening/lengthening of a filled triflex® R is required

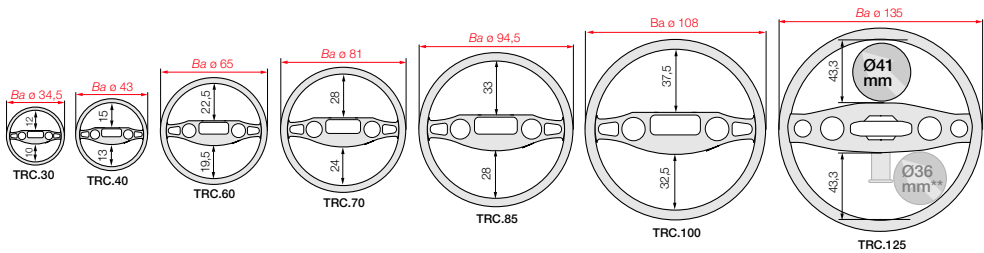

Optional | C-version - quick assembly, 50% higher forces

NEW in this catalog



Now available with proven bolt connection for even faster assembly and disassembly

- Linear pull force capacity increased up to 4.000 N
- Up to 4 times stronger and improved bending radius strength
- C-version drastically reduces installation time
- Stronger lock for torsion limitation
- igubal® Spherical Bearing for non-slip traction

www.igus.eu/3Dstabil

Order key
TRC. 40. 058. 0. C

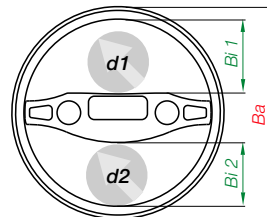

TRC - Closed design, dirt-resistant, with Bi 40 mm inner width and R 058 mm radius, color black = Part No. TRC.40.058.0

TRE- "Easy" Design -
simply press cables in

High tensile strength thanks to
special ball-and-socket principle

Able to move multi-dimensionally -
Twist up to approx. $\pm 10^\circ$ per link
possible in longitudinal axis

Easy opening mechanism for easy filling
with cable and hose packages

Excellent mechanical properties

Easy assembly and dismantling -
one die-cast component

High stability - thanks
to exterior stop dogs

Small bending radii and short pitch

igumid NB: -40° up to $+80^\circ$ C
VDE 0304 IIC UL94 V2

Easy attachment and intelligent
accessories onto the robot/machine

⊕ Robotic applications, easy filling

When to use Series TRE:

- If an easy to fill energy supply is required for multi-dimensional (3D) movements
- If high torsional stability is required
- If the system has to be shortened or lengthened easily
- If small bending radii are required
- If high tensile strength is important
- If an easy opening mechanism for easy filling with cable and hose packages is needed



When to use a different igus® Series:

- For circular movements with high loads
- ▶ **System twisterchain® new, from page 2.56**
- If a fully enclosed solution is required
- ▶ **triflex® R - TRC, page 2.12**
- If a more simple and low-cost 3D-solution is required
- ▶ **triflex® R - TRL, page 2.16**



triflex® R-Set - compact module for
all movements on robots available



Available from stock. Delivery in 24h or today!*

*Delivery time means time until shipping of goods



3D-CAD files, configurators, PDF ▶ www.triflex-r.eu

triflex® R | Series TRE | "Easy"-Design - simply press cables in

Series TRE Standard	Series TRE B-Version	Series TRE C-Version	Bi 1 [mm]	Bi 2 [mm]	Ba [mm]	R [mm]	d1** [mm]	d2** [mm]	Pitch [mm]	Links/m	Weight [kg/m]
TRE.30.050.0	-	-	12	10	34,5	050	10	8	11,3	89	≈0,26
TRE.40.058.0	TRE.40.058.0.B	-	15	13	43	058	13	11	13,9	72	≈0,36
TRE.60.087.0	TRE.60.087.0.B	-	22,5	19,5	65	087	20,5	17,5	20,4	49	≈0,83
TRE.70.110.0	TRE.70.110.0.B	-	28	24	81	110	26	22	25,6	39	≈1,30
TRE.85.135.0	TRE.85.135.0.B	-	33	28	94,5	135	31	26	30,6	33	≈1,67
TRE.100.145.0	TRE.100.145.0.B	TRE.100.145.0.C	37,5	32,5	108	145	35,5	30,5	34,5	29	≈2,35
TRE.125.182.0	-	X 1)	43,3	43,3	135	182	41	41 2)	44,6	23	≈4,40

1) TRE.125: C-version is standard!

2) Max. cable diameter Ø 41 mm. Max. cable diameter changes to Ø 36 mm only, if shortening/lengthening of a filled triflex® R is required

**For quick and easy insertion / removal of cables using the easy chain® principle, we recommend a maximum cable diameter of 70% of the specified value

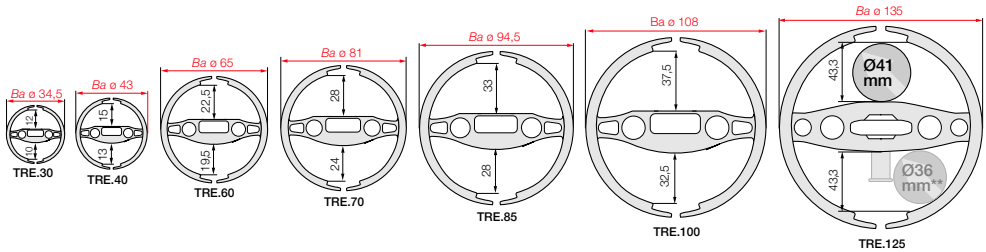

Optional | B-version - 4 x higher torsion forces

NEW in this catalog



The advanced ball and socket connection now uses an additional arrester for even higher stability. Especially designed for heavy duty applications with high accelerations and top speeds. ● Up to 4 times stronger with improved bending radius strength ● Able to handle even higher torsion forces ● Made of only one single part per e-chain® link ► www.igus.eu/3Dstabil

Optional | C-version - quick assembly, 50% higher forces

NEW in this catalog



Now available with proven bolt connection for even faster assembly and disassembly ● Linear pull force capacity increased up to 4.000 N ● Up to 4 times stronger and improved bending radius strength ● C-version drastically reduces installation time ● Stronger lock for torsion limitation ● igubal® Spherical Bearing for non-slip traction ► www.igus.eu/3Dstabil

Order key



TRE. 100. 145. 0. B/C



- Optional B-/C-version
- Standard color black
- Bending radius R
- Width index Ø
- Series / "Easy"-design

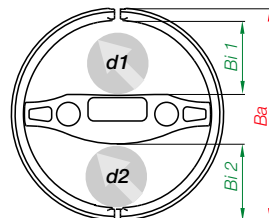

TRE - "Easy"-design, with Bi 40 mm inner width and R 058 mm radius, color black = Part No. TRE.40.058.0

TRL - light and low-cost alternative with "Easy" Design

High tensile strength thanks to special ball-and-socket principle

Able to move multi-dimensionally - Twist up to approx. $\pm 10^\circ$ per link possible in longitudinal axis

Easy opening mechanism for easy filling with cable and hose packages

Extremely light due to one-piece design

Easy assembly and dismantling - one die-cast component

igumid NB: -40° up to $+80^\circ$ C
VDE 0304 IIC UL94 V2

Small bending radii and short pitch

Economical and light mounting bracket with strain relief or intermediate link

⊕ Robotic applications, light and low-cost

When to use Series TRL:

- When an easy to fill, economical 3D e-chain® is needed
- When 3D e-chain® for easily manageable operating conditions is needed
- If the system has to be shortened or lengthened easily
- If small bending radii are required
- If an easy opening mechanism for easy filling with cable and hose packages is needed

When to use a different igus® Series:

- For circular movements with high loads
- ▶ **System twisterchain® new, from page 2.56**
- If a fully enclosed solution is required
- ▶ **triflex® R - TRC, page 2.12**
- When a rugged, easy to fill variant is needed
- ▶ **triflex® R - TRE, page 2.14**



Available from stock. Delivery in 24h or today!*

*Delivery time means time until shipping of goods



3D-CAD files, configurators, PDF ▶ www.triflex-r.eu

triflex® R | **Series TRL** | Light alternative with "Easy"-design

Series TRE Closed design	<i>Bi</i> 1 [mm]	<i>Bi</i> 2 [mm]	<i>Ba</i> [mm]	<i>R</i> mm	<i>d1</i> * mm	<i>d2</i> * mm	Pitch [mm]	Links/m	Weight [kg/m]
TRL.30.050.0	12	10	34,5	050	10	8	11,3	89	≈ 0,15
TRL.40.058.0	15	-	45	058	13	-	13,9	72	≈ 0,20
TRL.60.087.0	23	-	65	087	20,5	-	20,4	49	≈ 0,40
TRL.70.110.0	28	-	81	110	26	-	25,6	39	≈ 0,70
TRL.100.145.0	38	-	108	145	35,5	-	34,5	29	≈ 1,20

*For quick and easy insertion / removal of cables using the easy chain® principle, we recommend a maximum cable diameter of 70% of the specified value.

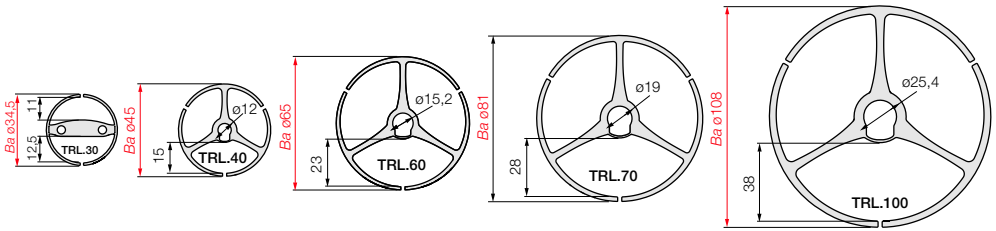

Order key
TRL. 70. 110. 0

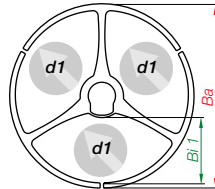

**TRL.30. with 2-chamber system



TRL - Light design, with *Bi* 70 mm inner width and *R* 110 mm radius, color black = Part No. **TRL.70.110.0**



Option: Standard mounting brackets

- Quick and easy fixing
- Short downtimes when swapping a harnessed triflex® R system
- Mounting bracket ① with strain relief available
- Mounting bracket also as ② intermediate link
- Quick assembly by means of spring locks
- Bracket holes for common robot types
- End and intermediate fixing possible

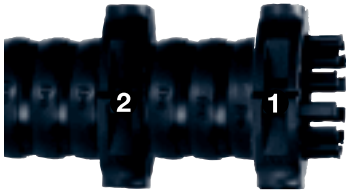

Dimensions and order configurations

Part No. structure

TR.60. 01. M6

- Option with insert nuts
- With strain relief
- Mounting bracket

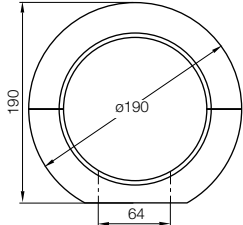
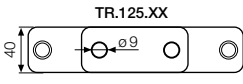

Mounting bracket with strain relief TR.XX.01

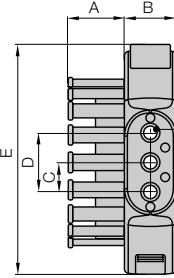

Mounting bracket as intermediate link TR.XX.02

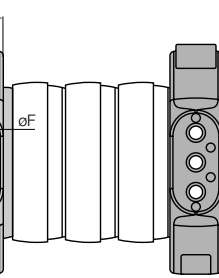

Mounting bracket without strain relief TR.XX.02

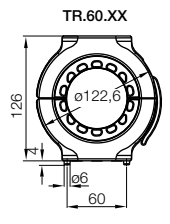
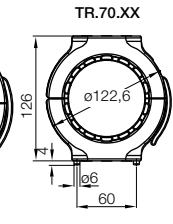
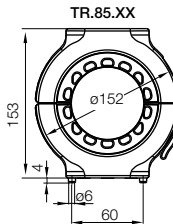
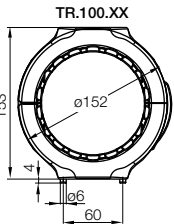
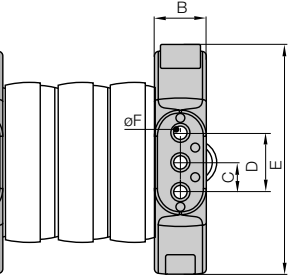

For Series		Mounting bracket with strain relief	Mounting bracket as intermediate link	Dim. A [mm]	Dim. B [mm]	Dim. C [mm]	Dim. D [mm]	Dim. E [mm]	Dim. ø F [mm]
TRC/TRE/TRL.30.	▶								
TRC/TRE/TRL.40.	▶	TR.40.01.M6	TR.40.02.M6	17,8	21	13,5	27	85	6,5
TRC/TRE/TRL.60.	▶	TR.60.01.M8	TR.60.02.M8	25	35	20	40	126	9
TRC/TRE/TRL.70.	▶	TR.70.01.M8	TR.70.02.M8	25	35	20	40	126	9
TRC/TRE.85.	▶	TR.85.01.M8	TR.85.02.M8	40	35	20	40	153	9
TRC/TRE/TRL.100.	▶	TR.100.01.M8	TR.100.02.M8	38	35	20	40	153	9
TRC/TRE.125.	▶	-	TR.125.02.M8						

TRC/TRE.125 Dimensions and delivery time upon request!

Strain relief is possible on the moving end and/or the fixed end.

Standard: Trough holes in ØF - Option: with insert nuts, steel, M6/M8

Phone +49- (0) 22 03-96 49-800
Fax +49- (0) 22 03-96 49-222

igus® GmbH
51147 Cologne

Internet: www.igus.eu
E-mail: info@igus.de



Option: Light mounting brackets

- Standard for TRL version, also compatible with all triflex® R variants (TRC/TRE)
- Mounting bracket ① with strain relief available
- Mounting bracket also as ② intermediate link available
- Economical and light
- For simple 3D-movements and loads
- Comprising two halves - easy to assemble



Mounting bracket with strain relief TL.XX.01.Z2

Mounting bracket as intermediate link TL.XX.01.Z0

Mounting bracket without strain relief TL.XX.01.Z0

Dimensions and order configurations

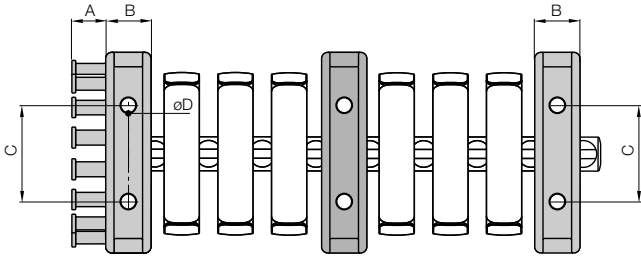

Part No. structure

TL.40.01. Z2

Intermediate link with strain relief
Light mounting bracket

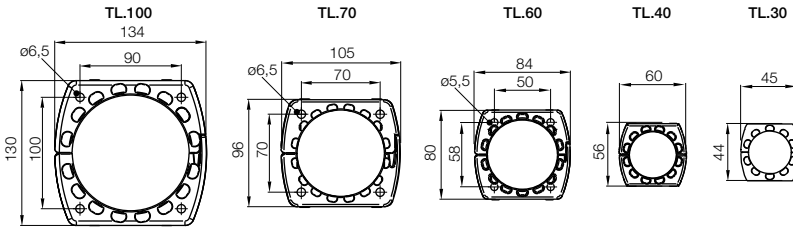

For Series	Part No.	Dim. A [mm]	Dim. B [mm]	Dim. C [mm]	Dim. ø D [mm]	For fixed end (socket)	For moving end (ball)	As intermediate link
TRC/TRE/TRL.30	▶ TL.30.01.Z0	○	13	24	4,5	TRC/TRE/TRL	TRC/TRE/TRL	TRC/TRE/TRL
	▶ TL.30.01.Z1	12,5	13	24	4,5	TRC/TRE/TRL	TRC/TRE/TRL	-
	▶ TL.30.01.Z2	20	13	24	4,5	TRC/TRE/TRL	TRC/TRE/TRL	-
TRC/TRE/TRL.40	▶ TL.40.01.Z0	○	14	36	5,8	TRC/TRE/TRL	TRC/TRE/TRL	TRC/TRE/TRL
	▶ TL.40.01.Z1	12,5	14	36	5,8	TRC/TRE/TRL	TRL	-
	▶ TL.40.01.Z2	20	14	36	5,8	TRC/TRE/TRL	TRC/TRE/TRL	-
TRC/TRE/TRL.60	▶ TL.60.01.Z0	○	20	48	5,8	TRC/TRE/TRL	TRC/TRE/TRL	TRC/TRE/TRL
	▶ TL.60.01.Z1	17	20	48	5,8	TRC/TRE/TRL	TRL	-
	▶ TL.60.01.Z2	27	20	48	5,8	TRC/TRE/TRL	TRC/TRE/TRL	-
TRC/TRE/TRL.70	▶ TL.70.01.Z0	○	27	64	6,5	TRC/TRE/TRL	TRC/TRE/TRL	TRC/TRE/TRL
	▶ TL.70.01.Z1	17,5	27	64	6,5	TRC/TRE/TRL	TRL	-
	▶ TL.70.01.Z2	27,5	27	64	6,5	TRC/TRE/TRL	TRC/TRE/TRL	-
TRC/TRE/TRL.100	▶ TL.100.01.Z0	○	30	64	6,5	TRC/TRE/TRL	TRC/TRE/TRL	TRC/TRE/TRL
	▶ TL.100.01.Z1	22,5	30	64	6,5	TRC/TRE/TRL	TRL	-
	▶ TL.100.01.Z2	42,5	30	64	6,5	TRC/TRE/TRL	TRC/TRE/TRL	-

○ = without strain relief - = not possible

Phone +49- (0) 22 03-96 49-800
Fax +49- (0) 22 03-96 49-222





Option: Swivel bearing - smooth motion

- To smoothen the motion of the cables requiring guidance, it is necessary to allow for extreme twisting and bending. This relieves cables with highly sensitive bending radii (such as fiber optic cables) when following a robot's movements. Swivel bearings are used to achieve this
- Available in 2 designs (with or without strain relief)
- Pivoted bearing with a maintenance-free igubal® ball-and-socket joint
- Minimization of critical bending cycles
- Gentler motion

Dimensions and order configurations

Part No. structure

TR.60.	03.	/04.
--------	-----	------

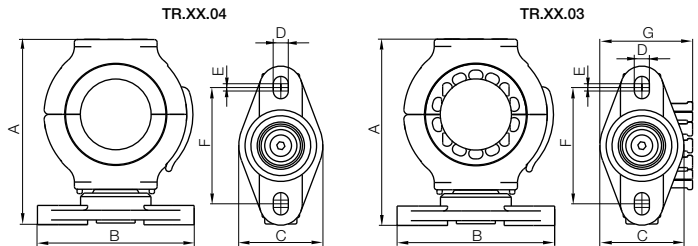

Phone +49- (0) 22 03-96 49-800
Fax +49- (0) 22 03-96 49-222



For Series	Swivel bearing with tie-rod plate	Swivel bearing as intermediate links	Dim.	Dim.	Dim.	Dim.	Dim.	Dim.	Dim.
			A [mm]	B [mm]	C [mm]	D [mm]	E [mm]	F [mm]	G* [mm]
TRC/TRE/TRL.40.	▶ TR.40.03	TR.40.04	105	89	47	8,4	4,1	65	51,8
TRC/TRE/TRL.60.	▶ TR.60.03	TR.60.04	152	118	65	10,5	5,5	87,5	73,5
TRC/TRE/TRL.70.	▶ TR.70.03	TR.70.04	152	118	65	10,5	5,5	87,5	73,5
TRC/TRE.85.	▶ TR.85.03	TR.85.04	179	118	65	10,5	5,5	87,5	88
TRC/TRE/TRL.100.	▶ TR.100.03	TR.100.04	179	118	65	10,5	5,5	87,5	88

*Only TR.XX.03

igus® GmbH
51147 Cologne

Strain relief systems (only for TRC/TRE) - Secure mounting of large cross sections with igus® standard chainfix clamps

- Available in 3 options per size
- Multiaxially adjustable, for ideal positioning
- Suits all additional axes: Ø 30 mm, Ø 32 mm, Ø 34 mm

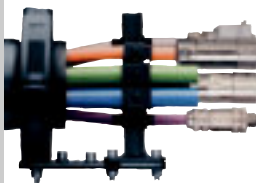

Product range clamps

Part No.	Part No. Stain-less Steel*	ø	B	H
		[mm]	[mm]	[mm]
CFX12.1	CFX12.1.E	6 - 12	16	58
CFX14.1	CFX14.1.E	12 - 14	18	50
CFX16.1	CFX16.1.E	14 - 16	20	52
CFX18.1	CFX18.1.E	16 - 18	22	54
CFX20.1	CFX20.1.E	18 - 20	24	56
CFX22.1	CFX22.1.E	20 - 22	26	58

Part No.	Part No. Stain-less Steel*	ø	B	H
		[mm]	[mm]	[mm]
CFX26.1	CFX26.1.E	22 - 26	30	67
CFX30.1	CFX30.1.E	26 - 30	34	71
CFX34.1	CFX34.1.E	30 - 34	38	75
CFX38.1	CFX38.1.E	34 - 38	42	79
CFX42.1	CFX42.1.E	38 - 42	46	83

*Material stainless steel: 1.4301

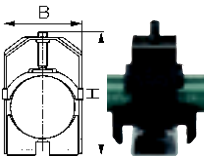

Internet: www.igus.eu
E-mail: info@igus.de

triflex® R Quick exchange kit
TR.60/70/85/100.22.XX

- Ideal for triflex® R readychain®
- One-time-only alignment
- No repeat alignment upon exchange of readychain®
- Exchange of th triflex® R unit incl. cables without any tools



For e-chain®	Part No. Quick exchange kit
TRC/TRE.60 ▶	TR.60.22. 30 / 32 / 34
TRC/TRE.70 ▶	TR.70.22. 30 / 32 / 34
TRC/TRE.85 ▶	TR.85.22. 30 / 32 / 34
TRC/TRE.100 ▶	TR.100.22. 30 / 32 / 34

For required additional axes Ø 30, 32, 34 mm, please add appropriate Index e.g. TR.100.22 30

triflex® R pivot bracket
TR.60/70/85/100.21.XX

- Available in 2 options per size (with/without strain relief)
- Safe and simple securing of the cables with cable ties
- Possible also without strain relief (Strain relief in the application)

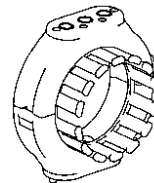

Pivot bracket with strain relief TR.XX21.01

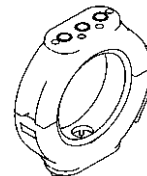

Pivot bracket with strain relief TR.XX21.02

For e-chain®	Part No. Pivot bracket with strain relief	Part No. Pivot bracket without strain relief
TRC/TRE.60 ▶	TR.60.21.01. 30 / 32 / 34	TR.60.21.02. 30 / 32 / 34
TRC/TRE.70 ▶	TR.70.21.01. 30 / 32 / 34	TR.70.21.02. 30 / 32 / 34
TRC/TRE.85 ▶	TR.85.21.01. 30 / 32 / 34	TR.85.21.02. 30 / 32 / 34
TRC/TRE.100 ▶	TR.100.21.01. 30 / 32 / 34	TR.100.21.02. 30 / 32 / 34

For required additional axes Ø 30, 32, 34 mm, please add appropriate Index e.g. TR.100.21.01 30

triflex® R connection
TR.60/70/85/100/125.20.XX

- In the use of cables with large cross section, e.g. welding applications or in heavy hydraulic hoses
- Double C rails for igus® CFX clips
- Rugged strain relief in "heavy-duty" applications
- igus® chainfix clamps made of stainless steel or steel can be used (see Table on the left)

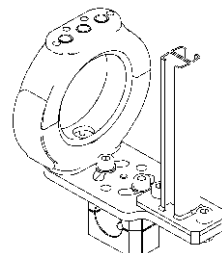

For e-chain®	Part No. connection
TRC/TRE.60 ▶	TR.60.20. 30 / 32 / 34
TRC/TRE.70 ▶	TR.70.20. 30 / 32 / 34
TRC/TRE.85 ▶	TR.85.20. 30 / 32 / 34
TRC/TRE.100 ▶	TR.100.20. 30 / 32 / 34
TRC/TRE.125 ▶	TR.125.20. 30 / 32 / 34

For required additional axes Ø 30, 32, 34 mm, please add appropriate Index e.g. TR.100.20 30



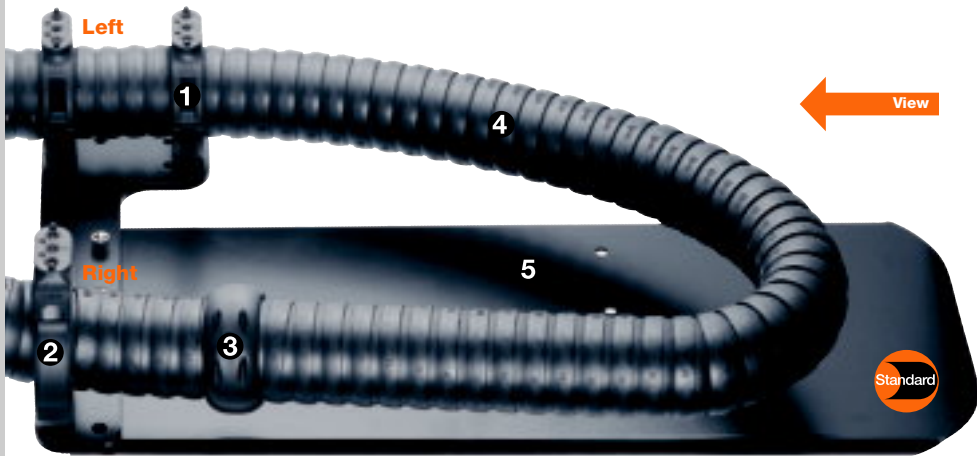

triflex® RS - Extremely flat design,
guides close to the robotic arm



Integrated recuperating spring
prevents loop formations

Universal module for any robotic motion

triflex® RS is a very compact universal module that can be attached to the fastening points on the robot. Applications in very limited space can be realized, thanks to the small installation height and to the fact that triflex® RS can be installed parallel to the robotic arm. triflex® RS with integrated spring mechanism allows efficient energy supply to the robotic head, without stress on the cables. The triflex® R kit offers all advantages of proven triflex® accessories, such as the FlexBar, universal assembly kit and fiber rod module in one system. All triflex® R features are also included in the universal triflex® RS module.

- **Standard-package** for all applications for immediate installation
- **Integrated spring mechanism**
- **The first choice for robotic applications with limited space**
- **Saves space - small installation height and closely routed on the robotic arm**
- **Outstanding service life**
- **Universal installation**

- ① Mounting brackets for safe fastening
- ② Glide lead-through for a close and parallel guidance on the robotic arm
- ③ Limit stop dog for a defined free movement
- ④ Integrated recuperating spring prevents loop formations
- ⑤ Single module, space-saving and quickly mounted on robot

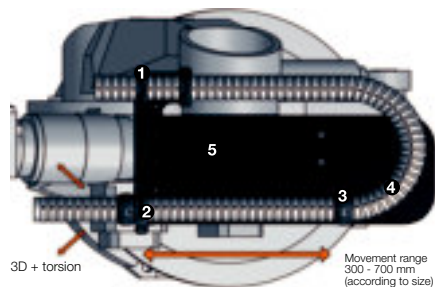

triflex® RS - Installation Dimensions

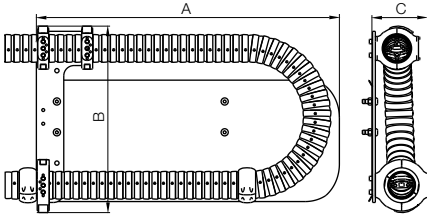

triflex® RS - Fastening point, right

Universal module	Part No.	A	B	C
TRS for Series		[mm]	[mm]	[mm]
TRC.40/TRE.40	▶ TRC/TRE.RS.40.R	620	301	95
TRC.60/TRE.60	▶ TRC/TRE.RS.60.R	885	528	150
TRC.70/TRE.70	▶ TRC/TRE.RS.70.R	885	545	167
TRC.85/TRE.85	▶ TRC/TRE.RS.85.R	885	565	167
TRC.100/TRE.100	▶ -	-	-	-

triflex® RS - Fastening point, right, with cover

Universal module	Part No.	A	B	C
TRS for Series		[mm]	[mm]	[mm]
TRC.40/TRE.40	▶ TRC/TRE.RS.40.RC	620	301	95
TRC.60/TRE.60	▶ TRC/TRE.RS.60.RC	885	528	150
TRC.70/TRE.70	▶ TRC/TRE.RS.70.RC	885	545	167
TRC.85/TRE.85	▶ TRC/TRE.RS.85.RC	885	565	167
TRC.100/TRE.100	▶ TRC/TRE.RS.100.RC	912,5	614	167

triflex® RS - Fastening point, left

Universal module	Part No.	A	B	C
TRS for Series		[mm]	[mm]	[mm]
TRC.40/TRE.40	▶ TRC/TRE.RS.40.L	620	301	95
TRC.60/TRE.60	▶ TRC/TRE.RS.60.L	885	528	150
TRC.70/TRE.70	▶ TRC/TRE.RS.70.L	885	545	167
TRC.85/TRE.85	▶ TRC/TRE.RS.85.L	885	565	167
TRC.100/TRE.100	▶ TRC/TRE.RS.100.L	912,5	614	167

triflex® RS - Fastening point, left, with cover

Universal module	Part No.	A	B	C
TRS for Series		[mm]	[mm]	[mm]
TRC.40/TRE.40	▶ TRC/TRE.RS.40.LC	620	301	95
TRC.60/TRE.60	▶ TRC/TRE.RS.60.LC	885	528	150
TRC.70/TRE.70	▶ TRC/TRE.RS.70.LC	885	545	167
TRC.85/TRE.85	▶ TRC/TRE.RS.85.LC	885	565	167
TRC.100/TRE.100	▶ -	-	-	-

Fastening point, right



triflex® R-Set with cover for the additional support of switch cabinets or valve terminals

triflex® R - More accessories available now ...



triflex® R-Set with cover (barrier)

- Creates more mounting space on robots - e.g. for switch cabinets or valve terminals
- For upside down applications
- Enables the use of triflex® RS in applications with extreme movements

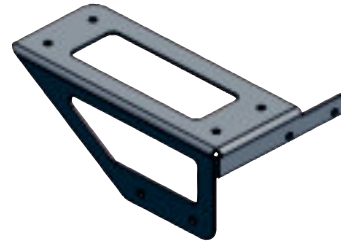

43 Adapter brackets for robots from stock

- 43 adapter bracket types from stock for many different robots
- For all triflex® RS modules
- For assembly to the side or on top
- Free download of 3D CAD files for many brackets ▶ www.igus.eu/triflexbrackets

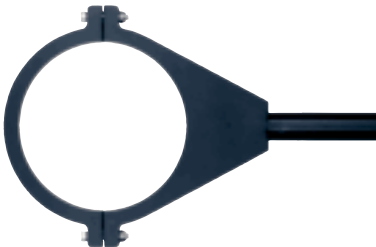

triflex® R fixation to axis 6
Part No. TR.907.667.Inner Ø

- One axis diameter (Ø30 mm) for all robots
- Easy and fast assembly
- For triflex® R mounting bracket with CFX clamps (TR.XX.20.30)
- For triflex® R mounting bracket with tiewrap plates (TR.XX21.30)
- For TR.XX.22.30 Quick exchange kit

triflex® R

Phone +49- (0) 22 03-96 49-800
Fax +49- (0) 22 03-96 49-222



▶ page 2.9-11

igus® e-chainsystems®

Phone +49- (0) 22 03-96 49-800
Fax +49- (0) 22 03-96 49-222

igus® GmbH
51147 Cologne

Internet: www.igus.eu
E-mail: info@igus.de

Other accessories available for special applications...



Fiber rod modules - Intelligent problem solution through directed pretension (for TRC/TRE)

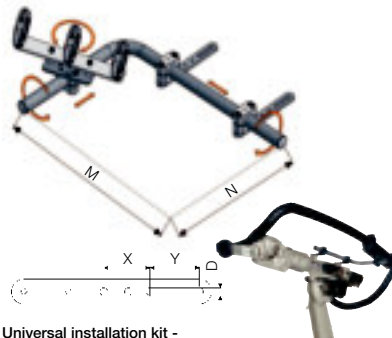

Universal installation kit - Easy engineering of the fiber rods (for TRC/TRE)

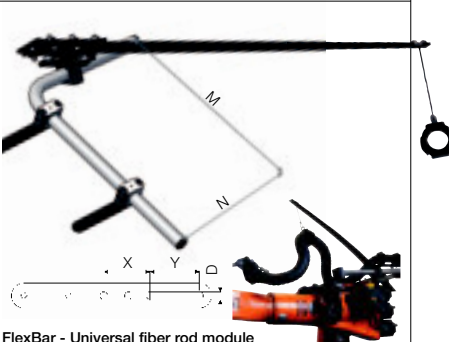

FlexBar - Universal fiber rod module for extreme robotic movements (for TRC/TRE)

The igus® universal module as standard triflex® R-Set ► page 2.22

Fiber rod module, universal assembly kit and FlexBar as individual parts for triflex® R

Fiber rod module: For applications where too much flexibility is not desired. **Universal installation kit:** Universal installation kit allows the attachment of fiber rod modules in any given position, relative to the robotic arm. **FlexBar:** For robot-applications with extreme movements in the 4th to 6th axis and avoidance from loops

Product range - Fiber rods

Part No. TRC/TRE with	Length ca. [m]	max. load [kg/m]
mounted fiber rods		
triflex® R 40	TRC.F.40.1000.1.0/TRE.F.40.1000.1.0	1,0 0,4
	TRC.F.40.0900.1.0/TRE.F.40.0900.1.0	0,9 0,5
	TRC.F.40.0800.1.0/TRE.F.40.0800.1.0*	0,8 0,6
	TRC.F.40.0700.1.0/TRE.F.40.0700.1.0	0,7 0,7
triflex® R 60	TRC.F.40.0600.1.0/TRE.F.40.0600.1.0	0,6 0,8
	TRC.F.40.0500.1.0/TRE.F.40.0500.1.0	0,5 0,9
	TRC.F.40.0400.1.0/TRE.F.40.0400.1.0	0,4 1,0
	TRC.F.60.1400.1.0/TRE.F.60.1400.1.0	1,4 1,0
triflex® R 80	TRC.F.60.1200.1.0/TRE.F.60.1200.1.0	1,2 1,2
	TRC.F.60.1000.1.0/TRE.F.60.1000.1.0*	1,0 1,4
	TRC.F.60.0800.1.0/TRE.F.60.0800.1.0	0,8 1,6
triflex® R 70	TRC.F.60.0600.1.0/TRE.F.60.0600.1.0	0,6 1,8
	TRC.F.60.0400.1.0/TRE.F.60.0400.1.0	0,4 2,0
	TRC.F.70.1800.1.0/TRE.F.70.1800.1.0	1,8 1,4
triflex® R 85	TRC.F.70.1600.1.0/TRE.F.70.1600.1.0	1,6 1,6
	TRC.F.70.1400.1.0/TRE.F.70.1400.1.0	1,4 1,8
	TRC.F.70.1200.1.0/TRE.F.70.1200.1.0*	1,2 2
	TRC.F.70.1000.1.0/TRE.F.70.1000.1.0	1,0 2,2
triflex® R 100	TRC.F.70.0800.1.0/TRE.F.70.0800.1.0	0,8 2,4
	TRC.F.85.2000.1.0/TRE.F.85.2000.1.0	2,0 1,4
	TRC.F.85.1800.1.0/TRE.F.85.1800.1.0	1,8 1,7
	TRC.F.85.1600.1.0/TRE.F.85.1600.1.0	1,6 1,9
triflex® R 100	TRC.F.85.1400.1.0/TRE.F.85.1400.1.0*	1,4 2,1
	TRC.F.85.1200.1.0/TRE.F.85.1200.1.0	1,2 2,3
	TRC.F.85.1000.1.0/TRE.F.85.1000.1.0	1,0 2,6
	TRC.F.85.0800.1.0/TRE.F.85.0800.1.0	0,8 3,0
	TRC.F.100.2000.1.0/TRE.F.100.2000.1.0	2,0 1,6
	TRC.F.100.1800.1.0/TRE.F.100.1800.1.0	1,8 2,0
TRC.F.100.1400.1.0/TRE.F.100.1400.1.0*	1,4 2,4	
TRC.F.100.1600.1.0/TRE.F.100.1600.1.0	1,6 2,2	
TRC.F.100.1200.1.0/TRE.F.100.1200.1.0	1,2 2,6	
TRC.F.100.1000.1.0/TRE.F.100.1000.1.0	1,0 3,0	

*recommended lengths of the fiber rods

Product range - Universal installation kit

Installation kit for Series	Part No.	X [mm]	Y [mm]	M [mm]	N [mm]	D [mm]
TRC/TRE.40	► TR.40.80	40	30	475	325	6,3
TRC/TRE.60	► TR.60.80	40	30	475	325	6,3
TRC/TRE.70	► TR.70.80	75	80	875	575	12,5
TRC/TRE.85	► TR.85.80	75	80	875	575	12,5
TRC/TRE.100	► TR.100.80	75	80	875	575	12,5

Product range - FlexBar

FlexBar for Series	Part No.	X [mm]	Y [mm]	M [mm]	N [mm]	D [mm]
TRC/TRE.60	► TR.60.90	40	30	475	325	6,3
TRC/TRE.70	► TR.70.90	75	80	875	575	12,5
TRC/TRE.85	► TR.85.90	75	80	875	575	12,5
TRC/TRE.100	► TR.100.90	75	80	875	575	12,5

triflex® R protectors - high safety under extreme operating conditions

- To achieve long life cycles under heavy loads resulting from impact or friction on the robot's e-chains®, optional protectors can be fitted at the contact points
- Easy assembly and quick replacement
- Abrasion-resistant TPU material
- Absorptive
- Light
- Easy gliding over edges
- Free positioning on any e-chain® link

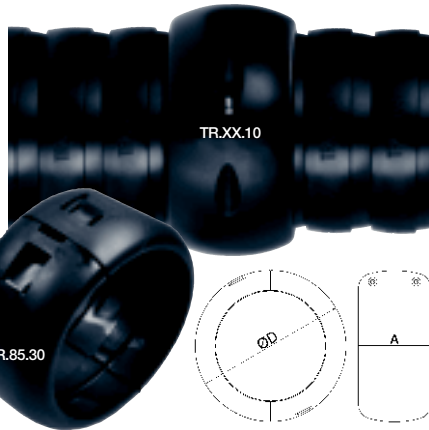

For Series	Part No. protectors	Ø D [mm]	A [mm]
TRC/TRE.40	▶ TR.40.10 upon request	55	27
TRC/TRE.60	▶ TR.60.10 upon request	80	40
TRC/TRE.70	▶ TR.70.10 upon request	102	50
TRC/TRE.85	▶ TR.85.10 TR.85.30	118	59
TRC/TRE.100	▶ TR.100.10 upon request	133	67
TRC/TRE.125	▶ TR.125.10 upon request	170	82

triflex® R cover: Heat shield - TR.XX.15

- Protection against weld spatter and metal splashes at temp. of up to 600°C (short-term)
- Base support: Fabric
- Coating: Aramid
- Easy to replace via longitudinally positioned velcro fastenings
- Elastic sealing strips
- Asbest-free
- Standard lengths available ex stock

For Series	TR.XX.15 Part No.	Standard lengths [mm]
TRC/TRE/TRL.40	▶ TR.40.15. YY	500 1000 1500 2000
TRC/TRE/TRL.60	▶ TR.60.15. YY	500 1000 1500 2000
TRC/TRE/TRL.70	▶ TR.70.15. YY	500 1000 1500 2000
TRC/TRE.85	▶ TR.85.15. YY	500 1000 1500 2000
TRC/TRE/TRL.100	▶ TR.100.15. YY	500 1000 1500 2000

YY = Jacket length



Standard protective jacket - TR.XX.16

- Temperature up to room temp.
- Base support: Fabric
- Coating: None
- Easy to replace via longitudinally positioned velcro fastenings
- Elastic sealing strips
- Silicon-free
- Standard lengths available ex stock

For Series	TR.XX.16 Part No.	Standard lengths [mm]
TRC/TRE/TRL.40	▶ TR.40.16. YY	500 1000 1500 2000
TRC/TRE/TRL.60	▶ TR.60.16. YY	500 1000 1500 2000
TRC/TRE/TRL.70	▶ TR.70.16. YY	500 1000 1500 2000
TRC/TRE.85	▶ TR.85.16. YY	500 1000 1500 2000
TRC/TRE/TRL.100	▶ TR.100.16. YY	500 1000 1500 2000

YY = Jacket length

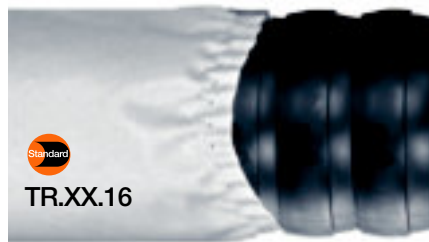

Light protective jacket - TR.XX.17

- Temperature up to room temp.
- Base support: Fabric (spun-bonded web)
- Coating: None
- Easy to replace via longitudinally positioned velcro fastenings
- Elastic sealing strips
- Silicon-free
- Standard lengths available ex stock

For Series	TR.XX.17 Part No.	Standard lengths [mm]
TRC/TRE/TRL.40	▶ TR.40.17. YY	500 1000 1500 2000
TRC/TRE/TRL.60	▶ TR.60.17. YY	500 1000 1500 2000
TRC/TRE/TRL.70	▶ TR.70.17. YY	500 1000 1500 2000
TRC/TRE.85	▶ TR.85.17. YY	500 1000 1500 2000
TRC/TRE/TRL.100	▶ TR.100.17. YY	500 1000 1500 2000

YY = Jacket length



triflex® R

Phone +49- (0) 22 03-96 49-800
Fax +49- (0) 22 03-96 49-222



Determining the cable area



Mounting bracket TR.70.01 - Strain relief for electric cables



We would be glad to help you in the selection of the right size with our triflex® R project planning software

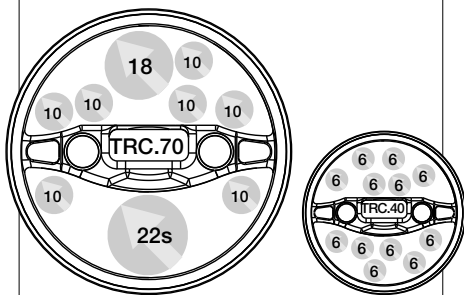

Examples of filling TRC.70 and TRC.40

Choice of the right e-chain® length

Filling and correct sizing - Clearance for cables and hoses is important when filling triflex® R, in order to compensate for friction forces due to relative movement between e-chain® and filling. The following serves as a rule of thumb: The total of all cable/hose diameters must not exceed 60% of the available cross section. A clearance of min. 10% (min. 1mm) needs to be maintained towards the next cable and the triflex® R. Please see the attached chart for available cross sections. igus® will be glad to run such calculations for you.

For Series	Effective areas [mm]	For Series	Effective areas [mm]
TRC/TRE.30	313	TRL.30	313
TRC/TRE.40	508	TRL.40	670
TRC/TRE.60	1144	TRL.60	1499
TRC/TRE.70	1788	TRL.70	2342
TRC/TRE.85	2431	-	-
TRC/TRE.100	3176	TRL.100	4125
TRC/TRE.125	4584	-	-

Example of determining cable area

$$A_{\text{Leitung}} = \frac{d^2 \times \pi}{4}$$

Examples:

$$A_1 = (10 \text{ mm} \times 10 \text{ mm} \times \pi) / 4$$

$$= 78,5 \text{ mm}^2 \times 7 \text{ (number of cables)}$$

$$= 549,50 \text{ mm}^2$$

$$A_2 = (18 \text{ mm} \times 18 \text{ mm} \times \pi) / 4$$

$$= 254,34 \text{ mm}^2$$

$$A_3 = (22 \text{ mm} \times 22 \text{ mm} \times \pi) / 4$$

$$= 379,94 \text{ mm}^2$$

$$A_{\text{Leitung}} = A_1 + A_2 + A_3 = 1183,7 \text{ mm}^2$$

The smaller the ratio between the effective area and the sum of the cable areas, the lower the load on the cables

Customer-specific special cable for robotic and torsion applications

- Control, motor, servo, bus and data cables
- Shielded and unshielded
- Outer jacket material: PVC, PUR, TPE
- Special cables from 500 m
- Torsion area according to requirement
- Sectors: Robotic and 3D applications

The service life of cables in torsion applications depend disproportionately on the exact progression of the angle of torsion and the cable length of the exact application. As a single test facility is often insufficient, chainflex® cables are tested on various constructional systems. Your torsion cables are tested as realistic as possible for your application. For this purpose, igus® uses up to 8 different test facilities in the in-house laboratory.

chainflex® robotic cables CF ROBOT - Twistable cables for robots available from stock

The proven CFROBOT cable family that is available from stock is now UL and CSA certified. All deliveries from 05/2011 are manufactured with the approvals.

- From 1 m, no minimum requirements
- ±180° on 1 m
- 3,000,000 cycles tested

More information ► www.igus.eu/chainflexnews

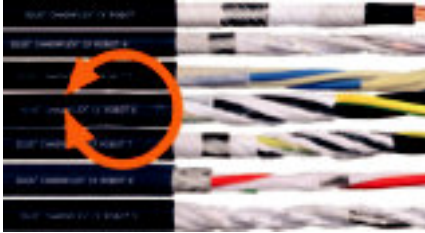

NEW in this catalog
CF77.ULD - chainflex® PUR control cable, ± 180° twistable

For twistable load requirements

More information ► www.igus.eu/chainflexnews



triflex® R - readychain® cable packages for robots

High component holding times and low downtimes are of the highest priority in manufacturing plants. With a triflex® R readychain® we design and develop a customized readychain® system for you, consisting of the "construction kits" triflex® R, chainflex® and igus® connectors. An installation can of course be executed by our triflex® R installation engineers on your site.

Your advantages:

- Reduces your storage costs to zero for cables, e-chain® and connectors
- Cuts your running time by half
- Responds flexibly to order variations
- Minimize machine downtimes
- Reduce the number of suppliers and orders by 75%

triflex® R - Tests in the igus® lab



Testing facility at the igus® laboratory



Torsion test of CF-ROBOT

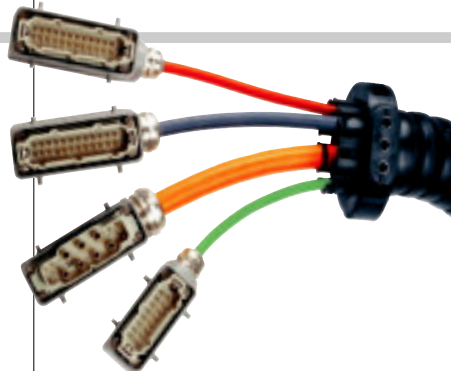

Ready-made packages in 3 to 10 days

triflex® R

Phone +49- (0) 22 03-96 49-800
Fax +49- (0) 22 03-96 49-222



► page 2.9-2.11



On-location assembly by the igus® specialist team



igus® system warranty - igus® warranty certificates will be issued for your application individually. "chain, cable, warranty"

We maximize your robot application's service life

Robot applications are very diverse and sometimes extremely complex in terms of configuration. To maximize your robot application's service life with triflex® R, igus® has a specially trained, robotics planning and installation team which can install triflex® R e-chains® into your applications. Minimize your planning effort by delegating as many tasks as possible to us. Our trained staff offer support toward smooth project implementation every step of the way - whether you simply want to consult our assembly team or have an entire system of machines planned and installed. By telephone we can always provide answers to a host of questions and point out all the advantages of triflex® R for your company. On site, we can acquire all the data necessary for preparing detailed planning documents. From project planning through customized quotations right up to expert installation of the triflex® R on your site, we remain at your service round the clock.

- We also offer guarantee certificates for complete systems
- No minimum order quantities, no surcharges
- 1500 staff in Germany and at 26 international subsidiaries and offices. Stations in over 30 other countries

Your advantage

- We are wherever you need us
- Your service requirements are fulfilled quickly by experts on location
- Guaranteed, fast worldwide delivery
- Spare parts are available from stock at short notice
- Order tracking via igus® "i-net" - www.igus.de/en/i-net



iF-award-winning triflex® R TRE for a safe energy supply also in office equipment



Cable management in a TV studio with triflex® R



igus® System E6 and triflex® R TRE in a Y/Z-gantry



Torsion testing of triflex® R in the igus® laboratory, Cologne



igus® E2 e-tube and triflex® R in a processing machine

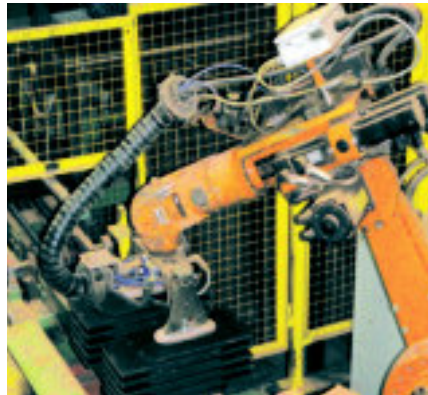

Optimal cable guidance even under extreme conditions, such as here in the Jungmeier roof tile plant

triflex® R

Phone +49- (0) 22 03-96 49-800
Fax +49- (0) 22 03-96 49-222



for 3D-applications
easy triflex®



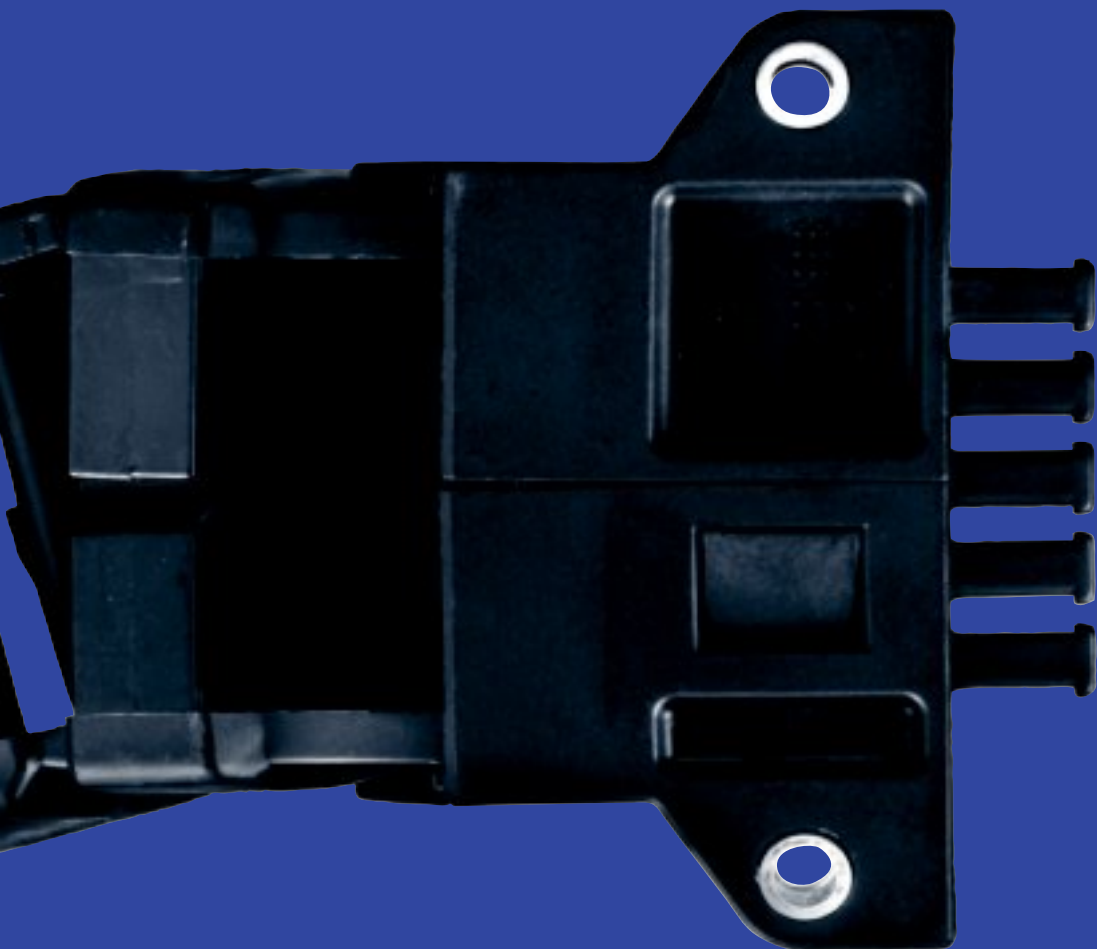

easy triflex® - e-chain® for 3D-applications

The triflex® Series was developed to realize safe energy supply in the case of multi-dimensional movements. In doing so the flexibility of a hose was combined with the stability of an e-chain® and its defined radii. With the easy triflex® the installation of cables, wires and hoses has also become child's play. In case of flexible crossbars the cables are now simply pushed into the e-chain® from above or below. The unique modular program allows you to follow very complex movements. For Example: Combine 1-axis, 2-axis and 3-axis movement links in one e-chain®.

Typical industries and applications

- Machine tools
- Robots
- Handling equipment
- Material handling
- Plastics machinery
- Construction machines
- Vehicles
- Machinery of all kinds
- Medical equipment
- Semicon office furniture



IF-Design awards for
easy triflex®-design



Torsional motion
possible



UL94-V2
classifications



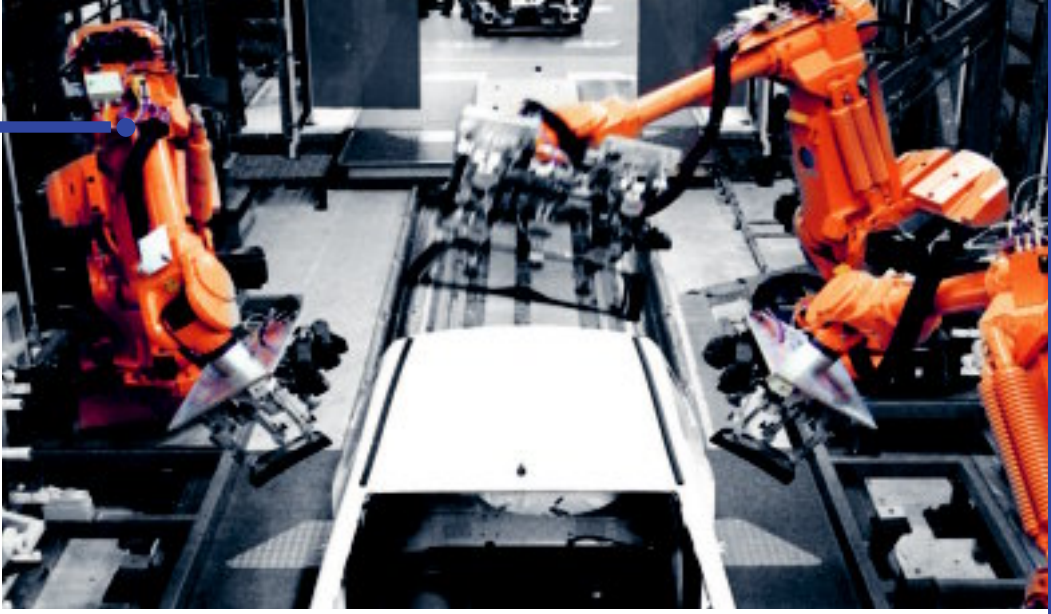

Robots with igus® easy triflex® e-chains® on an assembly line



easy triflex® e-chains® for multi-dimensional movements on a production line



easy triflex® e-chains® also for easy applications - here an aesthetic application

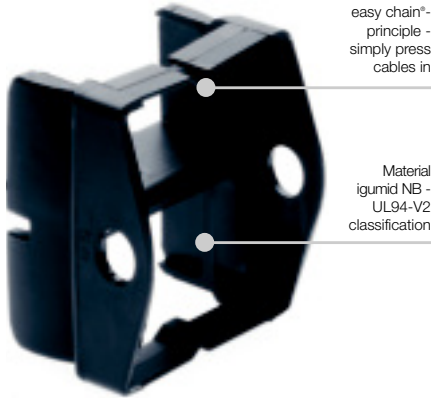

Select this modular e-chainsystem® for:

- 3-axis motions in all kinds of machinery
- Some robotics applications
- Very fast cable assembly with "Easy" principle
- Simple filling from two sides
- Where rectangular shapes fit better
- Combination of different bending radii and movement directions
- Lengthen and shorten anywhere
- KMA mounting brackets with integrated strain relief
- You can find more technical data about the material, chemical resistance, temperatures ► **chapter design, from page 1.38**

Selection table

Series	Inner height <i>Bi 1/Bi 2</i> [mm]	Inner width <i>Bi 3</i> [mm]	Outer width/Outer height <i>Ba</i> [mm]	Bending radii <i>R</i> [mm]	Page
--------	---------------------------------------	---------------------------------	--	--------------------------------	------

Single-axis and double-axis movement

E332.25	13	25	34	048 - 200	2.36
E332.32	17	32	50	075 - 250	2.36
E332.50	26	50	68	100 - 250	2.36
E332.75	38,5	75	96	140 - 300	2.36

Triple-axis movement

E333.25	13	25	34	048 - 200	2.36
E333.32	17	32	50	075 - 250	2.36
E333.50	26	50	68	100 - 250	2.36
E333.75	38,5	75	96	140 - 300	2.36

Assembling | easy triflex®



Twist and snap in



Shorten and lengthen
at any given point

Separating | easy triflex®

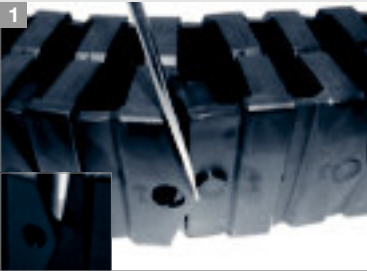

Lever the easy triflex®
side link with screwdriver



Twist and separate - For Series E333
you have to separate the "middle" pin

Filling | easy triflex®



Easy to fill - simply press cables in...



...and easy to take the cables out

● ● ● Price index



UL94-V2
classification



Torsional
motion possible



iF-Design awards for
easy triflex® design



Easy to fill - simply press cables in
and easy to take the cables out



When to use the Series E332/E333:

- If simple filling with complex movements is required
- If simple filling from both sides with complex movements is required
- For repair and supplementation of existing triflex® Systems



When not to use them:

- If complex robotics applications are required
 - ▶ triflex® R - TRE, from page 2.14
- For circular movements with high loads
 - ▶ System twisterchain®, from page 2.56
- If chip protection is necessary
 - ▶ System triflex®, from page 2.42

- 1 KMA split-open mounting bracket with integrated strain relief
- 2 Patented "push-button-principle"
- 3 Shorten and lengthen at any given point
- 4 Different bending radii and directions can be combined
- 5 Simple filling from 2 sides "easy chain™"-principle - simply press in cable along the inner radius or the outer radius
- 6 3-Axis motions in machinery of all kinds
- 7 Robotics applications possible
- 8 iF-Design Award Winner



Order example of a complete e-chain®

Indicate e-chain®-lengths or number of links! Example: 2 m or 68 links

2,0 m E333.50.100/100.0



e-chain®

1 set 333.50.12PZ



Mounting bracket



Series E332.25.2 - single/double-axis movement

R	048	075	100	125	150	175	200
H	130	185	235	285	335	385	435
D	095	125	150	175	200	225	250
K	195	280	360	440	515	595	675

Series E332.32.2 - single/double-axis movement

R	075	100	125	150	200	250
H	200	250	300	350	450	550
D	130	155	180	205	255	305
K	305	385	465	545	700	865

Series E332.50.2 - single/double-axis movement

R	100	125	150	200	250
H	270	320	375	470	570
D	195	220	245	295	345
K	435	520	590	750	910

Series E332.75.2 - single/double-axis movement

R	140	175	200	250	300
H	380	450	500	600	700
D	240	275	300	350	400
K	550	660	740	900	1060

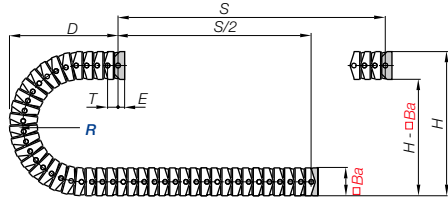

Series E332.25.2.

Pitch $T = 14,5$ mm/link
 Links/m = 69 (1000,5 mm)
 Dim. $E = 10$ mm
 $Ba = 34$ mm
 e-chain* length = $S/2 + K$

Series E332.32.2.

Pitch $T = 25$ mm/link
 Links/m = 40 (1000 mm)
 Dim. $E = 20$ mm
 $Ba = 50$ mm
 e-chain* length = $S/2 + K$

Series E332.50.2.

Pitch $T = 30$ mm/link
 Links/m = 34 (1020 mm)
 Dim. $E = 25$ mm
 $Ba = 68$ mm
 e-chain* length = $S/2 + K$

Series E332.75.2.

Pitch $T = 36$ mm/link
 Links/m = 28 (1008 mm)
 Dim. $E = 25$ mm
 $Ba = 96$ mm
 e-chain* length = $S/2 + K$

Series E333.25 - triple-axis movement

R	048	075	100	125	150	175	200
H	230	335	435	535	635	735	835
D	145	200	250	300	350	400	450
K	350	515	675	830	990	1150	1300

Series E333.32 - triple-axis movement

R	075	100	125	150	200	250
H	350	450	550	650	850	1050
D	205	255	305	355	455	555
K	545	700	860	1020	1300	1605

Series E333.50 - triple-axis movement

R	100	125	150	200	250
H	470	570	670	870	1070
D	295	345	395	495	595
K	750	910	1070	1380	1690

Series E333.75 - triple-axis movement

R	140	175	200	250	300
H	660	800	900	1100	1300
D	380	450	500	600	700
K	990	1210	1400	1700	2000

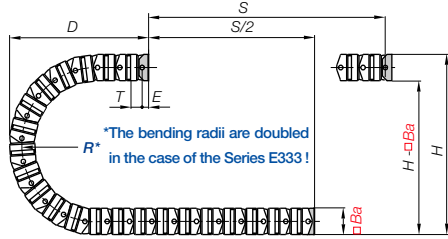

Series E333.25.

Pitch $T = 14,5$ mm/link
 Links/m = 69 (1000,5 mm)
 Dim. $E = 10$ mm
 $Ba = 34$ mm
 e-chain* length = $S/2 + K$

Series E333.32.

Pitch $T = 25$ mm/link
 Links/m = 40 (1000 mm)
 Dim. $E = 20$ mm
 $Ba = 50$ mm
 e-chain* length = $S/2 + K$

Series E333.50.

Pitch = 30 mm/link
 Links/m = 34 (1020 mm)
 Dim. $E = 25$ mm
 $Ba = 68$ mm
 e-chain* length = $S/2 + K$

Series E333.75.

Pitch = 36 mm/link
 Links/m = 28 (1008 mm)
 Dim. $E = 25$ mm
 $Ba = 96$ mm
 e-chain* length = $S/2 + K$

Technical Data



Details of material properties
 ► page 1.38

Material - permitted temperature °C igumid NB / -40° up to +80° C
 Flammability class, igumid NB VDE 0304 IIC UL94 V2



igus® e-chainsystems®

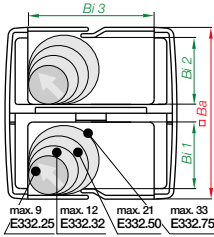

Single-axis movement - Series E332

Part No.	Bi 1/Bi 2 [mm]	Bi 3 [mm]	Ba [mm]	R [mm]	Bending radii	Weight [kg/m]
E332.25.2.□.0	13	25	34	048	075 100 125 150 175 200	≈ 0,70
E332.32.2.□.0	17	32	50	075	100 125 150 200 250	≈ 0,90
E332.50.2.□.0	26	50	68	100	125 150 200 250	≈ 1,40
E332.75.2.□.0	38,5	75	96	140	175 200 250 300	≈ 2,35

Supplement Part No. with required radius (R). Example: E332.50.2.100.0
0 = standard color, other colors ► page 1.39

Part No. structure

E332.	50.2.	100.	0
-------	-------	------	---



Part No.	Pitch [mm]
E332.25	14,5
E332.32	25
E332.50	30
E332.75	36

Phone +49- (0) 22 03-96 49-800
Fax +49- (0) 22 03-96 49-222

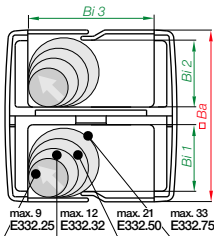

Double-axis movement - Series E332

Part No.	Bi 1/Bi 2 [mm]	Bi 3 [mm]	Ba [mm]	R [mm]	Bending radii	Weight [kg/m]
E332.25.2.□/□.0	13	25	34	048	075 100 125 150 175 200	≈ 0,70
E332.32.2.□/□.0	17	32	50	075	100 125 150 200 250	≈ 0,90
E332.50.2.□/□.0	26	50	68	100	125 150 200 250	≈ 1,40
E332.75.2.□/□.0	38,5	75	96	140	175 200 250 300	≈ 2,35

Supplement Part No. with required radius (R). Example: E332.75.2.200/200.0
0 = standard color, other colors ► page 1.39

Part No. structure

E332.	75.2.	200/200.	0
-------	-------	----------	---

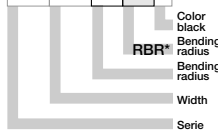

Part No.	Pitch [mm]
E332.25	14,5
E332.32	25
E332.50	30
E332.75	36

igus® GmbH
51147 Cologne

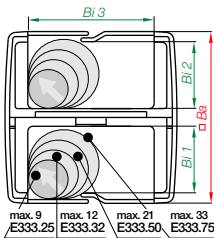

Triple-axis movement - Series E333

Part No.	Bi 1/Bi 2 [mm]	Bi 3 [mm]	Ba [mm]	R [mm]	Bending radii	Weight [kg/m]
E333.25.□/□/□.0	13	25	34	048	075 100 125 150 175 200	≈ 0,70
E333.32.□/□/□.0	17	32	50	075	100 125 150 200 250	≈ 0,90
E333.50.□/□/□.0	26	50	68	100	125 150 200 250	≈ 1,40
E333.75.□/□/□.0	38,5	75	96	140	175 200 250 300	≈ 2,35

The bending radii are doubled in the case of the Series E333 !

Supplement Part No. with required radius (R). Example: E333.50.100/100.0
0 = standard color, other colors ► page 1.39

Part No. structure

E333.	50.	100/100.	0
-------	-----	----------	---

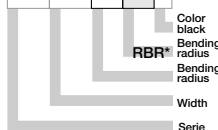

Part No.	Pitch [mm]
E333.25	14,5
E333.32	25
E333.50	30
E333.75	36

Internet: www.igus.eu
E-mail: info@igus.de



Option KMA* - The Standard

- Bolted connection outside of e-chain* cross-section
- Split-on KMA mounting bracket
- Corrosion-resistant
- Available with or without strain relief tiwrap plates
- Universal mountable with attachment capability on all sides

*KMA = Polymer Metal Mounting Bracket

Moving end with bore
333...1PZ(B)

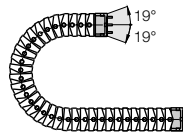

333...2PZ(B)

Fixed end with pin



These fastening variants result automatically on selection of divisible KMA mounting brackets

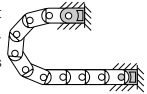

333...1PZ(B)

Moving end

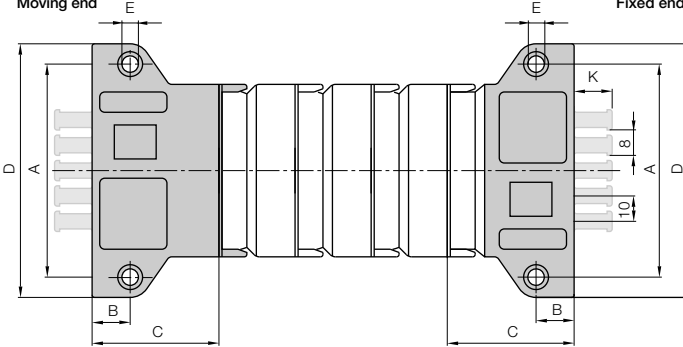

333...2PZ(B)

Fixed end

Dimensions and order configurations

For high loads, we recommend screwing the mounting brackets to the e-chain*. Contact us if you have any questions.

Part No. structure

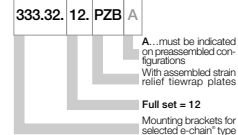

Full set, for both ends:

333. 32. 12.PZB +tiwrap plate

Single-part order:

333. 32. 1.PZB +tiwrap plate

Mounting bracket with bore

333. 32. 2.PZB +tiwrap plate

Mounting bracket with pin

For e-chain*	Part No. Full set with tiwrap plate	Part No. Full set without tiwrap plate	Dim. A [mm]	Dim. B [mm]	Dim. C [mm]	Dim. D [mm]	Dim. E [mm]	Dim. K [mm]	Number of teeth
E332.25.2 / E333.25	-	333.25.12.PZ	43	7	22	52	4,5	-	-
E332.32.2 / E333.32	333.32.12.PZB	333.32.12.PZ	66	15	46	82	6,5	15	3
E332.50.2 / E333.50	333.50.12.PZB	333.50.12.PZ	84	15	50	100	6,5	15	5
E332.75.2 / E333.75	333.75.12.PZB	333.75.12.PZ	109	15	55	125	6,5	15	7

For the preassembled mode please add the index **A** eg. 333.25.12.PZB **A**

Tiwrap plate as individual part

Special tiwrap plates for easy triflex® with KMA mounting brackets

- Single-piece for installation inside switch cabinets or machine assembly
- Easy to assemble, no need for screws

Part No. Tiwrap plate	Width [mm]	Number of teeth	For Series
333.32.ZB	40	3	E332.32.2 / E333.32
333.50.ZB	58	5	E332.50.2 / E333.50
333.75.ZB	83	7	E332.75.2 / E333.75

Phone +49- (0) 22 03-96 49-800
Fax +49- (0) 22 03-96 49-222



▶ page 2.35



Option steel - flange

- One part for all e-chain* widths
- Electrically conductive
- Flush mounting
- Galvanized steel
- Bolted connection outside of e-chain* cross-section

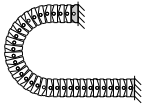

Frontal attachment option
in the case of steel flange
mounting brackets

Moving end with bore
330...1

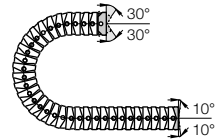

330...2

Fixed end with pin

Phone +49- (0) 22 03-96 49-800
Fax +49- (0) 22 03-96 49-222

igus GmbH
51147 Cologne

Internet: www.igus.eu
E-mail: info@igus.de

**Dimensions and
order configurations**

330...2
Fixed end

330...1
Moving end

Part No. structure

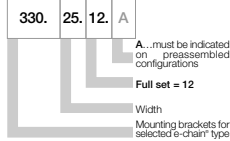

Full set, 4 parts

2 with pin / 2 with bore:

330. 25. 12

Single-part order:

330. 25. 1

Mounting bracket with bore

330. 25. 2

Mounting bracket with pin

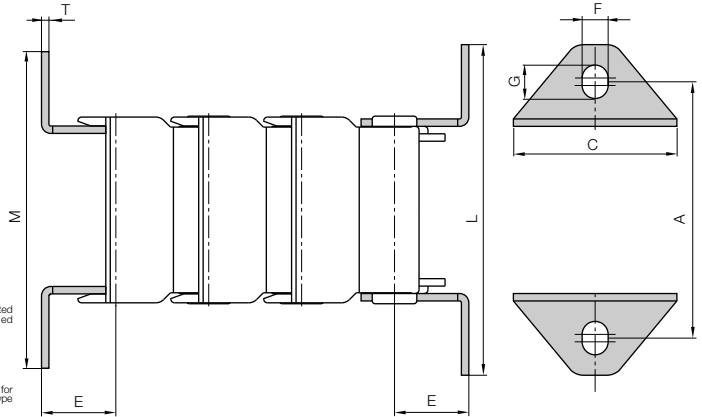

For e-chain*	Part No. Full set	A [mm]	M [mm]	C [mm]	L [mm]	T [mm]	E [mm]	F [mm]	G [mm]
E332.25.2 /E333.25	330.25. 12	44	55	29	55	1,5	10,5	6,5	9
E332.32.2 /E333.32	330.32. 12	66	84	44	88	2	20	7	9
E332.50.2 /E333.50	330.50. 12	84	102	62	106	2	25	7	9
E332.75.2 /E333.75	330.75. 12	109	127	90	131	2	25	7	9

For the preassembled mode please add the index **A**, eg. 330.25. 12 **A**



Option steel - angle

- One part for all e-chain® widths
- Bolted connection outside of e-chain® cross-section
- Electrically conductive
- Galvanized steel
- Bolted connection outside of e-chain® cross-section possible

Moving end with bore
338...1

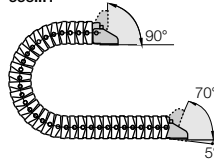

338...2

Fixed end with pin

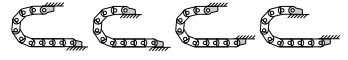

Possible installation conditions -
Further installation angles ► installation sketch

338...2
Fixed end

338...1
Moving end

Dimensions and order configurations

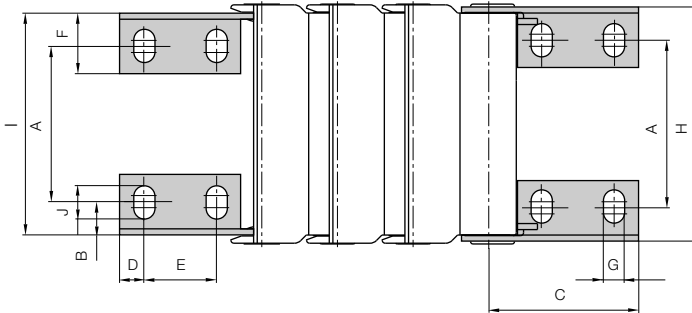

Part No. structure

338.	25.	12.
------	-----	-----

Full set = 12

Width

Mounting brackets for selected e-chain® type

Full set, 4 parts

2 with pin / 2 with bore:

338.	25.	12.
------	-----	-----

Single-part order:

338.	25.	1
------	-----	---

Mounting bracket with bore

338.	25.	2
------	-----	---

Mounting bracket with pin

For e-chain®	Part No. Full set	A [mm]	B [mm]	C [mm]	D [mm]	E [mm]	F [mm]	G [mm]	H [mm]	I [mm]	J [mm]
E332.25.2 / E333.25	► 338.25.12	17	6,25	28	6	16	14	5,5	33,8	31	8,5
E332.32.2 / E333.32	► 338.32.12	24	5,5	47	8	24	20	7	49	45	11
E332.50.2 / E333.50	► 338.50.12	42	5,5	77	12	35	24	9	67	62	15
E332.75.2 / E333.75	► 338.75.12	65	5,5	77	12	35	24	9	95	90	15

Phone +49- (0) 22 03-96 49-800
Fax +49- (0) 22 03-96 49-222



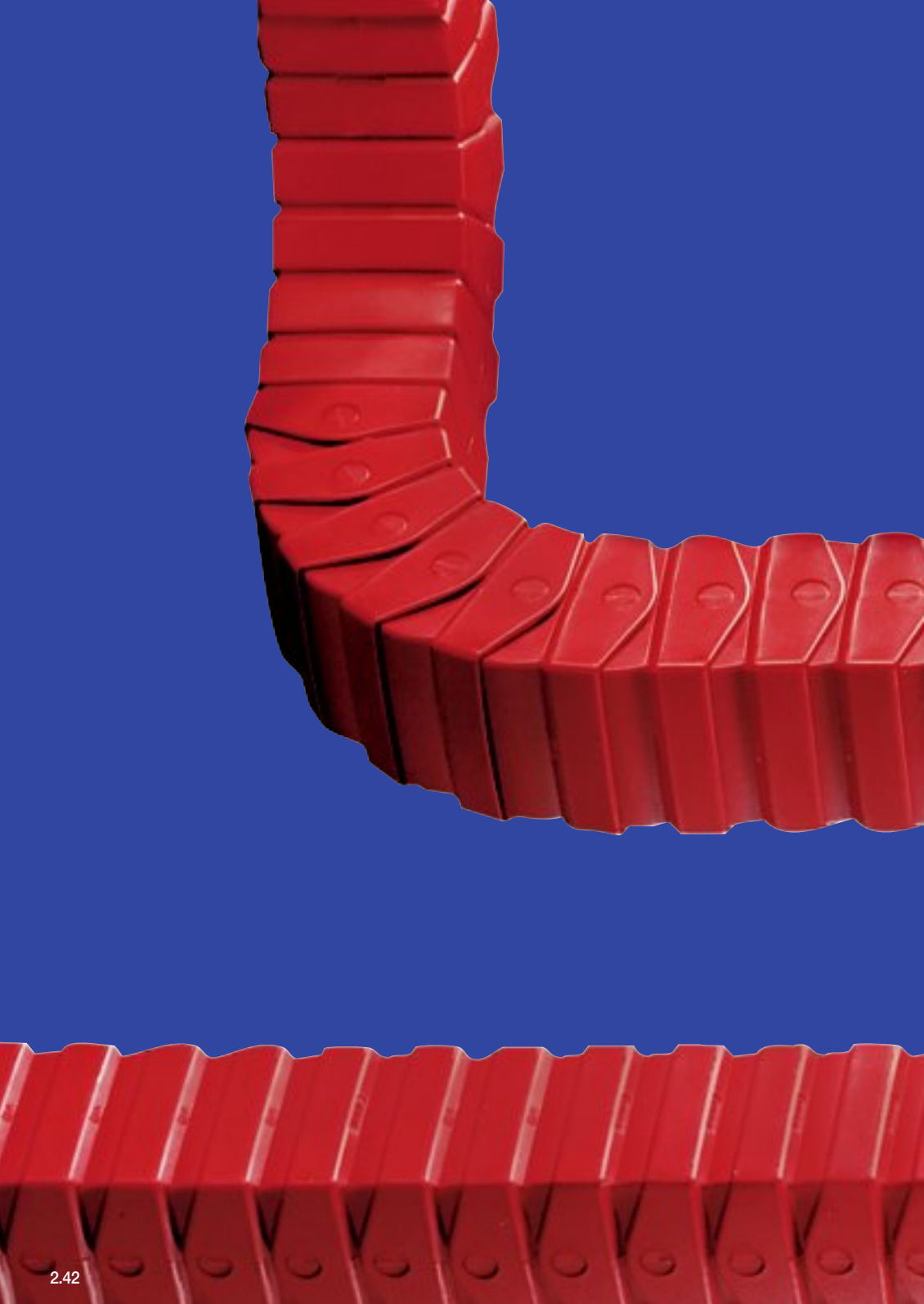

triflex[®]

Closed, 3D-applications

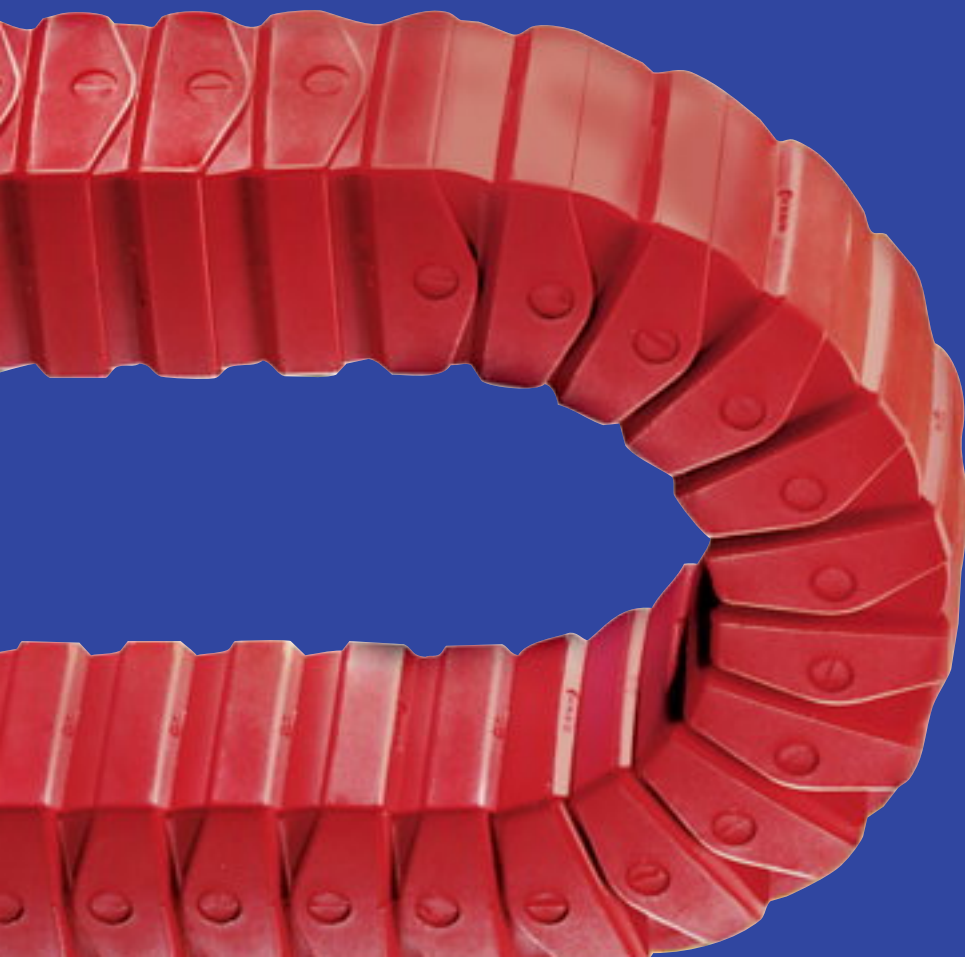

triflex® - enclosed, 3D applications

triflex® - e-chain® for 3D-motion. The triflex® Series was developed to realize safe energy supply in the case of multi-dimensional movements. In doing so the flexibility of a hose was combined with the stability of an e-chain® and its defined radii. The unique modular program allows you to follow very complex movements. For example: Combine 1-axis, 2-axis and 3-axis movement links in one e-chain®.

Typical industries and applications

- Machine tools
- Robots
- Handling equipment
- Material handling
- Plastics machinery
- Construction machines
- Vehicles
- Machinery of all kinds
- Medical equipment



iF-Design awards
for triflex® design



Torsional motion
possible



UL94-V2
classifications

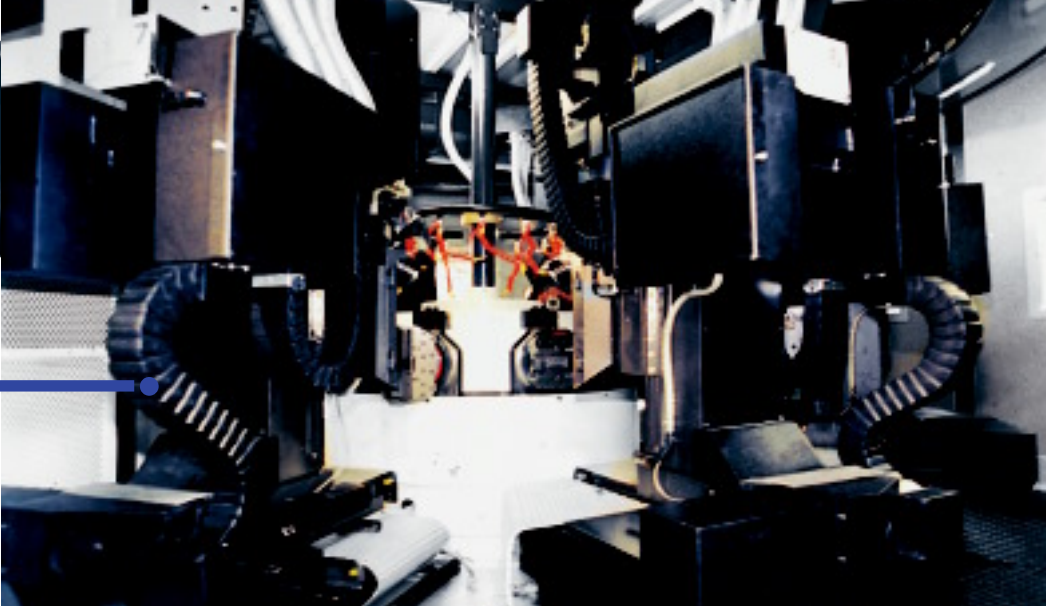

Various triflex® e-tubes on the inside of a machining center



triflex® for 3 movement directions combined with triflex® for 1 movement direction



triflex® 332 as unsupported link from machines to control desk

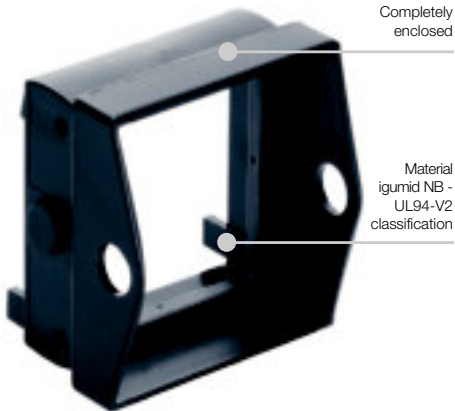

Select this modular, robust, e-chainsystem® for:

- 3-axis motions in machinery of all kinds
- Dirty environments
- High tensile strength
- Where rectangular shapes fit better
- Side-mounted unsupported
- Completely enclosed - protection against dirt and chips
- Combinations of varying bending radii and moving axes
- Connecting and separating possible at every link
- Flanged mounting brackets or mounting brackets angle, galvanized steel
- Series 352 and 353 snap-open, 50 mm cross-section
- Combination Series 353/333 possible
- Cost-effective design for complex movements
- You can find more technical data about the material, chemical resistance, temperatures ► **chapter design, from page 1.38**

Selection table

Series	Inner height/Inner width	Outer width/Outer height	Bending radii	Page
	□ Bi [mm]	□ Ba [mm]	R [mm]	
Single-axis and double-axis movement:				
332.16	16	26	038 - 100	2.48
332.32	32	50	075 - 250	2.48
332.50	50	68	100 - 250	2.48
332.75	75	96	140 - 300	2.48
Triple-axis movement:				
333.16	16	26	038 - 100	2.48
333.32	32	50	075 - 250	2.48
333.50	50	68	100 - 250	2.48
333.75	75	96	140 - 300	2.48
Snap-open Series:				
352.50	50	68	100 - 250	2.48
353.50	50	68	100 - 250	2.48

Assembling | triflex®



Twist and snap in



Snap in pin "push-button-principle"

Separating | triflex®



Release side link



Twist and separate

Filling | triflex® - Serien 352 und 353



To open Series 352 and Series 353 only - Insert screwdriver into slot on top of lid and push down

Price index



Torsional motion possible



iF-Design awards for triflex® design



Release side link, twist and separate



To open Series 352 and Series 353 only - Insert screwdriver into slot on top of lid and push down



When to use the Series 332/333/352/353:

- For applications that move within two or three axes (combined rotary and circular movements)
- If chip protection is required



When not to use them:

- For complex robotic applications
 - ▶ triflex® R - TRC, from page 2.12
- For gliding applications, use other e-chains*/Tubes of similar dimensions
 - ▶ System E4, chapter 7
- For rotary movements
 - ▶ System twisterchain®, from page 2.56



- ① KMA, flanged and angled mounting brackets available
- ② Combinations of varying bending radii and moving axes
- ③ Completely enclosed
- ④ Protection against dirt and chips
- ⑤ Combination of Series 353 and Series 333 possible
- ⑥ Series 352 and 353 snap-open, 50mm cross-section
- ⑦ Cost-effective design for complex movements
- ⑧ Assembling and separating at any given point
- ⑨ High tensile strength



Order example of a complete e-chain®

Indicate e-chain®-lengths or number of links! Example: 2 m or 68 links

2,0 m 332.50.100/100.0

 e-chain®

with 2 separators 351 assembled every 2nd link

 Interior separation

1 set 338.50.12

 Mounting bracket



332.16 - single/double-axis movement

R	038	048	075	100
H	105	125	180	230
D	070	080	105	130
K	200	230	315	400

332.32 - single/double-axis movement

R	075	100	125	150	200	250
H	200	250	300	350	450	550
D	130	155	180	205	255	305
K	305	385	465	545	700	865

332.50/352.50 - single/double-axis movement

R	100	125	150	200	250
H	270	320	375	470	570
D	195	220	245	295	345
K	435	520	590	750	910

332.75 - single/double-axis movement

R	140	175	200	250	300
H	380	450	500	600	700
D	240	275	300	350	400
K	550	660	740	900	1060

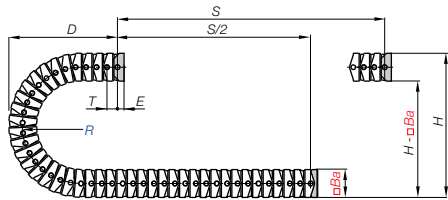

Series 332.16

Pitch = 13,3 mm
Links/m = 76 (1011 mm)
Dim. **E** = 10 mm
Ba = 26 mm
e-chain* length = $S/2 + K$

Series 332.32

Pitch = 25 mm
Links/m = 40 (1000 mm)
Dim. **E** = 20 mm
Ba = 50 mm
e-chain* length = $S/2 + K$

Series 332.50/352.50

Pitch = 30 mm
Links/m = 34 (1020 mm)
Dim. **E** = 25 mm
Ba = 68 mm
e-chain* length = $S/2 + K$

Series 332.75

Pitch = 36 mm
Links/m = 28 (1008 mm)
Dim. **E** = 25 mm
Ba = 96 mm
e-chain* length = $S/2 + K$

333.16 - triple-axis movement

R	038	048	075	100
H	180	220	330	430
D	105	125	180	230
K	320	380	550	710

333.32 - triple-axis movement

R	075	100	125	150	200	250
H	350	450	550	650	850	1050
D	205	255	305	355	455	555
K	545	700	860	1020	1300	1605

333.50/353.50 - triple-axis movement

R	100	125	150	200	250
H	470	570	670	870	1070
D	295	345	395	495	595
K	750	910	1070	1380	1690

333.75 - triple-axis movement

R	140	175	200	250	300
H	660	800	900	1100	1300
D	380	450	500	600	700
K	990	1210	1400	1700	2000

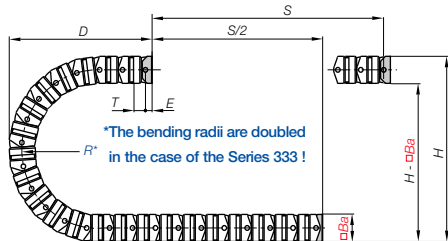

Series 333.16

Pitch = 13,3 mm
Links/m = 76 (1011 mm)
Dim. **E** = 10 mm
Ba = 26 mm
e-chain* length = $S/2 + K$

Series 333.32

Pitch = 25 mm
Links/m = 40 (1000 mm)
Dim. **E** = 20 mm
Ba = 50 mm
e-chain* length = $S/2 + K$

Series 333.50/353.50

Pitch = 30 mm
Links/m = 34 (1020 mm)
Dim. **E** = 25 mm
Ba = 68 mm
e-chain* length = $S/2 + K$

Series 333.75

Pitch = 36 mm
Links/m = 28 (1008 mm)
Dim. **E** = 25 mm
Ba = 96 mm
e-chain* length = $S/2 + K$

Technical Data



Details of material properties
► page 1.38

Material - permitted temperature °C igumid G / -40° up to +120 C
Flammability class, igumid G VDE 0304 IIC UL94 HB



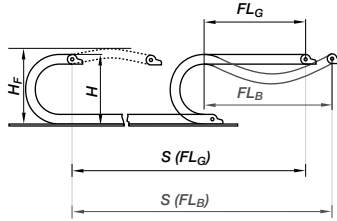

Unsupported length

FL_G = with straight upper run

FL_B = with permitted sag

Further information ► **Design, page 1.12**

S = Length of travel

H = Nominal clearance height

H_F = Required clearance height

Unsupported length 332.16

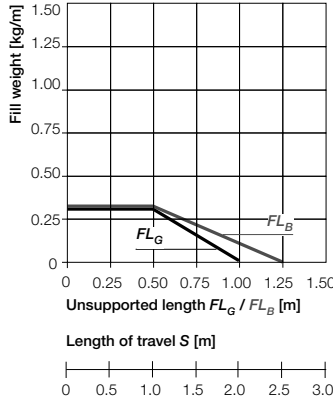

Unsupported length 332.32

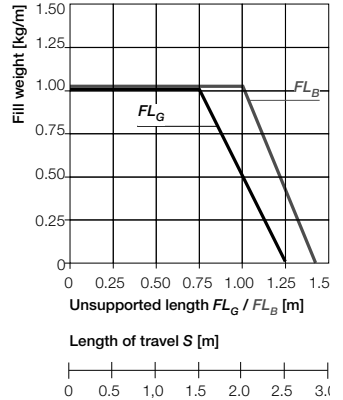

Unsupported length 332.50/352.50

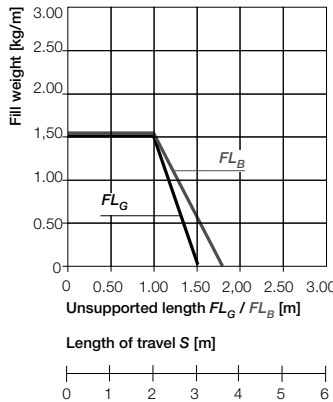

Unsupported length 332.75

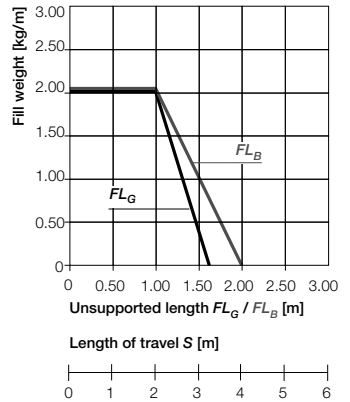

Unsupported lengths for single-axis movement only!

Single-axis movement - enclosed Series 332/snap-open Series 352

Part No.	□ Bi [mm]	□ Ba [mm]	R [mm]	Bending radii	Weight [kg/m]
332.16.□.0	16	26	038	048 075 100	≈ 0,33
332.32.□.0	32	50	075	100 125 150 200 250	≈ 0,90
332.50.□.0	50	68	100	125 150 200 250	≈ 1,40
332.75.□.0	75	96	140	175 200 250 300	≈ 2,35

Snap-open Series

352.50.□.0	50	68	100	125 150 200 250	≈ 1,40
------------	----	----	-----	-----------------	--------

Supplement Part No. with required radius (R). Example: 332.50.100.0

0 = standard color, other colors ▶ page 1.39



Part No.	Pitch [mm]
332.16	13,3
332.32	25
332.50	30
332.75	36
352.50	30

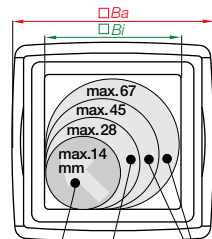

332.16/332.32/332./352.50/332.75

Part No. structure

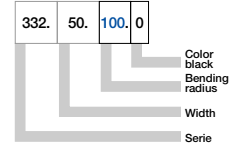

triflex®

Double-axis movement - enclosed Series 332/snap-open Series 352

Part No.	□ Bi [mm]	□ Ba [mm]	R [mm]	Bending radii	Weight [kg/m]
332.16.□/□.0	16	26	038	048 075 100	≈ 0,33
332.32.□/□.0	32	50	075	100 125 150 200 250	≈ 0,90
332.50.□/□.0	50	68	100	125 150 200 250	≈ 1,40
332.75.□/□.0	75	96	140	175 200 250 300	≈ 2,35

Snap-open Series

352.50.□/□.0	50	68	100	125 150 200 250	≈ 1,40
--------------	----	----	-----	-----------------	--------

Supplement Part No. with required radius (R). Example: 332.50.200/200.0

0 = standard color, other colors ▶ page 1.39

*RBR = Reversal Bending Radius



Part No.	Pitch [mm]
332.16	13,3
332.32	25
332.50	30
332.75	36
352.50	30

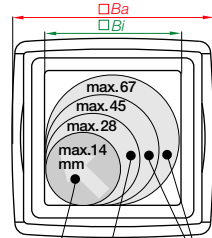

332.16/332.32/332./352.50/332.75

Part No. structure

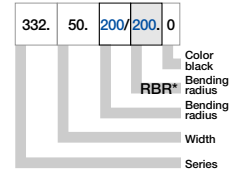

Phone +49- (0) 22 03-96 49-800
Fax +49- (0) 22 03-96 49-222

Triple-axis movement - enclosed Series 333/snap-open Series 353

Part No.	□ Bi [mm]	□ Ba [mm]	R [mm]	Bending radii	Weight [kg/m]
333.16.□/□.0	16	26	038	048 075 100	≈ 0,33
333.32.□/□.0	32	50	075	100 125 150 200 250	≈ 0,90
333.50.□/□.0	50	68	100	125 150 200 250	≈ 1,40
333.75.□/□.0	75	96	140	175 200 250 300	≈ 2,35

Snap-open Series

353.50.□/□.0	50	68	100	125 150 200 250	≈ 1,40
--------------	----	----	-----	-----------------	--------

Supplement Part No. with required radius (R). Example: 333.50.100/100.0

0 = standard color, other colors ▶ page 1.39

*RBR = Reversal Bending Radius

The bending radii are doubled in the case of the Series 333!



Part No.	Pitch [mm]
333.16	13,3
333.32	25
333.50	30
333.75	36
353.50	30

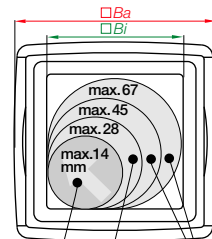

333.16/333.32/333./353.50/333.75

Part No. structure

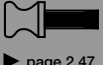
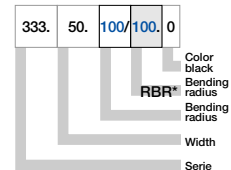

▶ page 2.47

Vertical Separators

Modular separators are available as interior separation for the igus® triflex® System. They can be used for both vertical and horizontal sub-division. If the separators are assembled every other link and turned 90°, the e-tube can be sub-divided into four segments. We recommend ordering the e-tube preassembled, as subsequent assembly of separators is only possible after dismantling the e-tube. Please note that assembled separators have a different part number than unassembled separators.



Horizontal subdividing

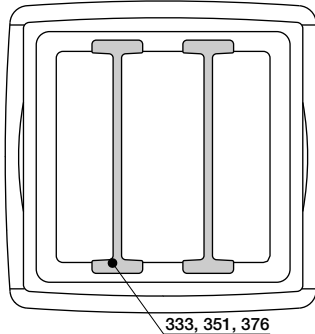

Vertical subdividing

332.75/333.75

Vertical Separator

unassembled	375
assembled	376

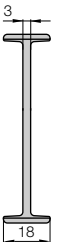
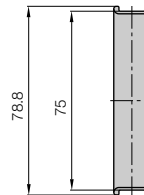

332.50/333.50/352.50/353.50

Vertical Separator

unassembled	350
assembled	351

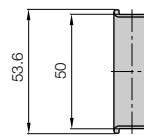

332.32/333.32

Vertical Separator

unassembled	332
assembled	333

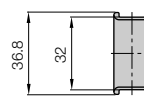



Option KMA* - The Standard

- Bolted connection outside of e-chain* cross-section possible
- Split-on KMA mounting bracket
- Corrosion-resistant
- Available with or without strain relief tiwrap plates
- Universal mountable with attachment capability on all sides

*KMA = Polymer Metal Mounting Bracket

Moving end with bore
333...1PZ(B)

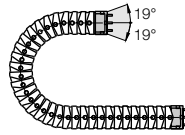

333...2PZ(B)

Fixed end with pin

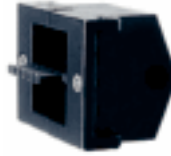

These fastening variants result automatically on selection of dividable KMA mounting brackets

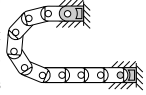

333...1PZ(B)

Moving end

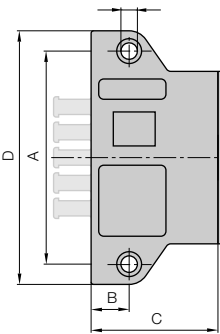

333...2PZ(B)

Fixed end

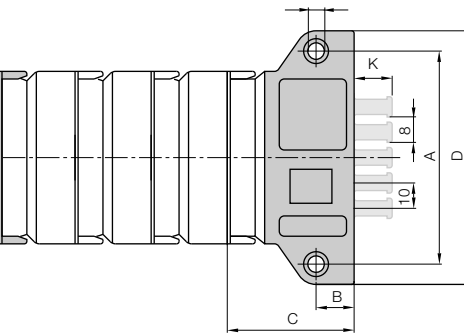

Dimensions and order configurations

For high loads, we recommend screwing the mounting brackets to the e-chain*. Contact us if you have any questions.

Part No. structure

333.32.12.PZB.A

A... must be indicated on preassembled configurations
With assembled strain relief tiwrap plates
Full set = 12
Mounting brackets for selected e-chain* type

Full set, for both ends:

333.32.12.PZB + tiwrap plate

Single-part order:

333.32.1.PZB + tiwrap plate

Mounting bracket with bore

333.32.2.PZB + tiwrap plate

Mounting bracket with pin

For e-chain*	Part No. Full set with tiwrap plate	Part No. Full set without tiwrap plate	Dim. A [mm]	Dim. B [mm]	Dim. C [mm]	Dim. D [mm]	Dim. E [mm]	Dim. K [mm]	Dim. Number of teeth
332.32 / 333.32 ▶	333.32.12.PZB	333.32.12.PZ	66	15	46	82	6,5	15	3
332.50 / 333.50 ▶	333.50.12.PZB	333.50.12.PZ	84	15	50	100	6,5	15	5
332.75 / 333.75 ▶	333.75.12.PZB	333.75.12.PZ	109	15	55	125	6,5	15	7
Snap-open series									
352.50 / 353.50 ▶	333.50.12.PZB	333.50.12.PZ	84	15	50	100	6,5	15	5

For the preassembled mode please add the index [A] eg. 333.32.12.PZB [A]

Tiewrap plate as individual part

Special tiewrap plates for triflex® e-chains®

- Application:** ● Single-piece for installation inside switch cabinets or machine assembly
● Accessory for igus® e-chainsystems® ● Easy to assemble, no need for screws

Part No.	Width [mm]	Number of teeth	For Series
333.32.ZB	40	3	332.32 / 333.32
333.50.ZB	58	5	332.50 / 333.50 352.50 / 353.50
333.75.ZB	83	7	332.75 / 333.75

Phone +49- (0) 22 03-96 49-800
Fax +49- (0) 22 03-96 49-222

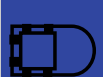

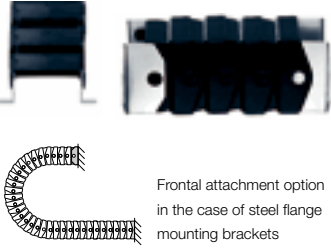

Option steel - flange

- One part for all e-chain* widths
- Electrically conductive
- Flush mounting
- Galvanized steel
- Bolted connection outside of e-chain* cross-section possible

Moving end with bore
330...1

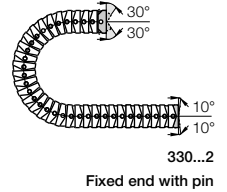

Dimensions and order configurations

330...2
Fixed end

330...1
Moving end

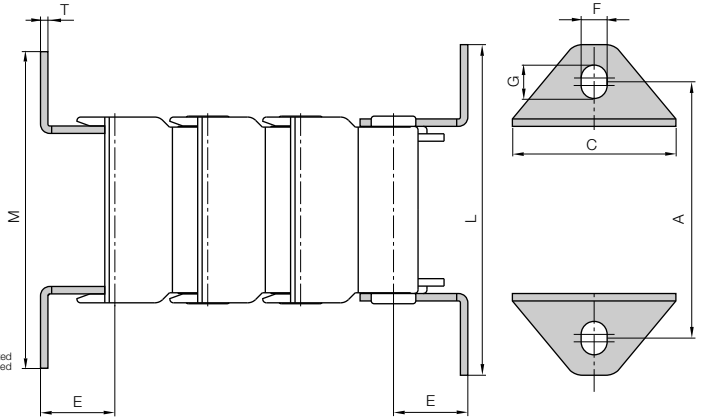

Part No. structure

330. 32. 12. A

A... must be indicated on preassembled configurations

Full set = 12

Width

Mounting brackets for selected e-chain* type

Full set, 4 parts

2 with pin / 2 with bore:

330. 32. 12

Single-part order:

330. 32. 1

Mounting bracket with bore

330. 32. 2

Mounting bracket with pin

For e-chain*	Part No. Full set	A [mm]	M [mm]	C [mm]	L [mm]	T [mm]	E [mm]	F [mm]	G [mm]
332.16 / 333.16 ▶	330.16. 12	35	53	21	57	1	10	4,5	6
332.32 / 333.32 ▶	330.32. 12	66	84	44	88	2	20	7	9
332.50 / 333.50 ▶	330.50. 12	84	102	62	106	2	25	7	9
332.75 / 333.75 ▶	330.75. 12	109	127	90	131	2	25	7	9
Snap-open Series									
352.50 / 353.50 ▶	330.50. 12	84	102	62	106	2	25	7	9

For the preassembled mode please add the index **A**, eg. 330.32. 12 **A**

Phone +49- (0) 22 03-96 49-800
Fax +49- (0) 22 03-96 49-222

igus GmbH
51147 Cologne

Internet: www.igus.eu
E-mail: info@igus.de



Option steel - angle

- One part for all e-chain® widths
- Bolted connection outside of e-chain® cross-section possible
- Electrically conductive
- Galvanized steel
- These elements can be screwed to the floor or roof

Moving end with bore
338...1

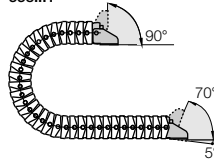

338...2

Fixed end with pin

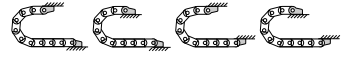

Possible installation conditions -
Further installation angles ► installation sketch

338...2
Fixed end

338...1
Moving end

Dimensions and order configurations

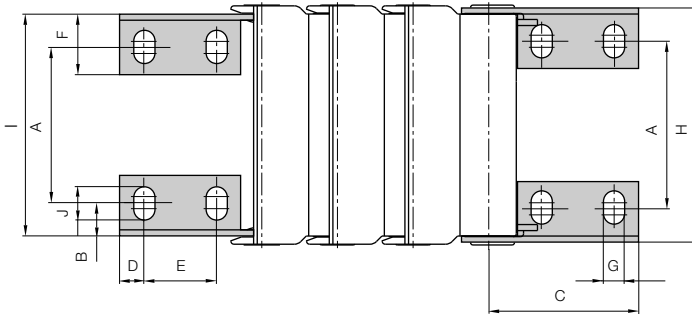

For e-chain*	Part No. Full set	A [mm]	B [mm]	C [mm]	D [mm]	E [mm]	F [mm]	G [mm]	H [mm]	I [mm]	J [mm]
332.16 / 333.16 ►	338.16.12	12	3	25	5	10	11	4,5	25	23	6
332.32 / 333.32 ►	338.32.12	24	5,5	47	8	24	20	7	49	45	11
332.50 / 333.50 ►	338.50.12	42	5,5	77	12	35	24	9	67	62	15
332.75 / 333.75 ►	338.75.12	65	5,5	77	12	35	24	9	95	90	15
Snap-open Series											
352.50 / 353.50 ►	338.50.12	42	5,5	77	12	35	24	9	67	62	15

Part No. structure

338.	32.	12.
------	-----	-----



Full set, 4 parts

2 with pin / 2 with bore:

338.	32.	12
------	-----	----

Single-part order:

338.	32.	1
------	-----	---

Mounting bracket with bore

338.	32.	2
------	-----	---

Mounting bracket with pin

Phone +49- (0) 22 03-96 49-800
Fax +49- (0) 22 03-96 49-222

